

ENVIRONMENT MANAGEMENT PLAN

Installation of 1.5 MW of Rooftop Solar Photovoltaic System at Hulhumale Island

Prepared by Development Advisory Services (DAS Pvt Ltd)

4 April 4, 2016



Table of Contents

Table of Contents	i
1 Project Brief	1
2 Introduction	2
3 Project Description.....	2
4 Legal requirements	2
5 Implementation Plan	3
6 Environment Management Plan	3
6.1 Potential Impacts	3
6.1.1 Noise pollution	3
6.1.2 Chemical pollution	3
6.1.3 Light or heat reflection	4
6.1.4 Impacts on Biodiversity.....	4
6.1.5 Waste	4
6.1.6 Occupational Health and Safety.....	4
6.1.7 Social impacts.....	4
6.2 Management Plan.....	5
6.3 Monitoring Plan	8
7 Grievance Mechanism	8
7.1 First Tier	9
7.2 Second Tier.....	9
7.3 Third Tier.....	9
8 Consultants Declaration.....	10
9 Community consultations	11
10 Implementation Plan	12
11 Layout Drawings.....	13

Environment Management Plan for Installation of 1.5 MW Rooftop Solar Photovoltaic System in Hulhumale'

1 Project Brief

Project Name: Installation of 1.5 MW of Rooftop Solar Photovoltaic System at Hulhumale Island

Project Location: Hulhumale Island

Consultants: Ali Shareef (EIA consultant, EIA 19/11)
Zammath Khaleel (Energy systems)

Proponent: Hulhumale Renewable Energy Company Pvt Ltd

Proponent Signature:

Date:

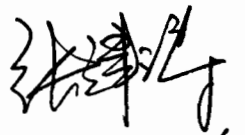

04.04.2016.

2 Introduction

Accelerating Sustainable Private Investment in Renewable Energy (ASPIRE) is part of the Maldives Scaling-Up Renewable Energy Program (SREP) which aims to encourage private sector involvement in the renewable energy sector of the Maldives. The first phase ASPIRE involves installations 1.5MW of rooftop PV in Hulhumale'. This phase will be implemented by Hulhumale Renewable Energy Company Pvt Ltd a joint venture formed by China Machinery Engineering Corporation (CEMEC) and Graess Solartechnik Schwiz.SA (Switzerland).

Roofs and common areas of the social housing unit in Hulhumale is owned by Hulhumale Development Corporation until tenants of individual units make the full payment. Payments to individual units are made on a monthly basis and individual units can be owned by the tenants, shortest within 10 years and longest within 25 years from the date of signing the agreement.

3 Project Description

Scaling up Renewable Energy Programme (SREP) is a Climate Investment funded project to transform the electricity generation sector in Maldives. SREP is implemented in two parts, one is Accelerating Sustainable Private Investments in Renewable Energy (ASPIRE) administered through World Bank and Preparing Outer Islands for Sustainable Energy Development (POISED) administered through Asian Development Bank (ADB).

ASPIRE considers to develop projects conducive of private sector investments and it aims for a 20 MWp of solar PV investment in Male' City. ASPIRE also aims to increase the private sector participation in investing in renewable energy in Maldives. ASPIRE is planned to be carried out in a phased approach. In the first phase 4 MWp solar PV is being considered on design, build, finance, own, operate and transfer (DFBOOT) model.

This sub-project involves installation of 1.5 MW rooftop solar PV on rooftop of "1000 housing" blocks in Hulhumale. This is 1.5 MW from the planned 4 MW. The government invited interested parties for proposals for this project on 12th April 2015. The proposal submitted by China Machinery Engineering Corporation (CEMEC) and Graess Solartechnik Schwiz.SA (Switzerland) was selected on 10th September 2015.

Framed glas-glas modules of 250W with Sungrow SG20KTL inverters will be used. In total, 5976 PV modules (1.494 MW) with 83 inverters will be installed. In addition, 83 electric meters and 35 monitoring units will be put in place.

4 Legal requirements

The project was followed by the signing of Implementation Agreement (IA) with Government and Power Purchasing Agreement (PPA) with STELCO on 15th October 2015. The project was proposed to be implemented on the rooftops of 37 social housing blocks in Hulhumale. A Roof Lease Agreement is to be signed between the contractor and Hulhumale Development Corporation (as the current owner of the roof). These three agreements (Implementation Agreement, Power Purchasing Agreement and Roof Lease Agreement) outlines the terms, conditions and rights of all the parties involved and is considered binding. Should there be any legal issues, these agreements would be referred to.

5 Implementation Plan

The installation of the panels is scheduled to start on 27 June 2016 and to be completed within 14 weeks. Commissioning and testing is scheduled to start on the 13 week (19 September 2016). Summary of the implementation plan is provided below.

- Detailed measurement of the roof areas and cable runs would be carried out.
- Site survey for potential interconnection between houses will be carried.
- Adjustment of planning documents as per the requirements of the ministry and the standards.
- Manufacturing of the materials
- Delivery and site setup
- Installation and site clearance
- Commissioning and testing

Details of the schedule and the implementation plan is attached in the annex.

6 Environment Management Plan

The environment management plan is a tool used to integrate environmental safeguards into a development project. The plan described below, is tailor made to minimize the impacts from the project, based on the nature of the work and the surrounding environment.

6.1 Potential Impacts

The project involves installation of rooftop solar PV in an already developed urban environment. There is little to no maintenance required for solar PV and the components of the systems are mostly chemically inert ruling out the potential of it being a source of contaminant to the environment. The only foreseeable negative environmental impact would be due to the installation activities carried out. In addition to environmental impacts, as the installations are done in residential area, there is likely going to be social implication. These environment and social issues that are likely to arise are listed out below;

6.1.1 Noise pollution

Although there is no noise emissions from operation of rooftop solar PV, the construction stage may involve increased noise due to the heavy machineries used. As the installation is happening in residential blocks where already people are living the impact of noise could prove disruptive for their daily life.

6.1.2 Chemical pollution

Chemical pollution is generally not associated with use of solar panels. However, it is important to note that chemical like cadmium is used in manufacturing of certain photovoltaic modules (thin film solar cells). This issue has also been raised in the consultations in which one tenant raised an objection citing the harmful materials that make up solar panels (refer Annex). However, these chemicals are not used for manufacturing mono- and poly-crystalline PV. Therefore risk of contamination from these specific harmful chemicals is non-existent. However, as Solar PV installation have electronic components to it, solar PV waste is considered as hazardous E-waste. This is a concern during decommissioning and disposal of the PV.

6.1.3 Light or heat reflection

The surface of solar PV is smooth and reflective and can reflect light the neighboring building based on the tilt of the panel and time of day. If such a reflection affects nearby buildings and neighbors it is likely to become a source of grievance. It is also important to note that the reflection of light from the PV could also pose an issue for the airplanes that operate to the nearby Ibrahim Nasir International Airport. However this could be easily rectified by keeping the tilt of the solar PV small and providing proper information with the airport authorities.

In addition to reflection, the dark texture of solar PV increasing the heat absorption can lead to slight increase in temperature on the roof.

6.1.4 Impacts on Biodiversity

As this is a newly developed urban area developed on reclaimed land, there is little natural vegetation in the area. And it is envisaged that there would be no requirements to clear any vegetation for the access of machinery and installations.

6.1.5 Waste

Most of the waste is likely to be generated in the installation and the decommissioning of the system. During the installation process, environmentally hazardous waste such as oil, fuel and paint, are generated that needs to be taken special care of.

At decommissioning, the panels become waste. As mentioned earlier these are considered e-waste and should be treated as a hazardous waste. At present there is no special treatment or facilities for e-waste in the Maldives. Until such an option is available these waste should be contained and stored. A temporary storage facility for this e-waste should be establish with guidance from MEE.

6.1.6 Occupational Health and Safety

Installation works require workers to operate on the roof with heavy equipment. There is always the risk of accidents during such a work. Contractor must ensure that all workers are provided and equipped with fully functional personal protective and safety equipment. The contractor must ensure that heavy duty equipment such as cranes and winches are safe with regular inspection.

There is also risk to the pedestrians and people living in the building from the anything falling from the roofs during project. Thus the tenant must be informed appropriately in addition to setting up safety nets. Similarly, it would be important to regularly monitor for any structural damage on the buildings during the project time frame.

As this involves electrical works, there is risk of fire during the installation and operation of solar PV. Therefore contractor should ensure fire safety procedures and equipment are in place as well as inform the tenants of the fire safety plans.

6.1.7 Social impacts

Social issues are likely going to be a key issue for this sub-project. As there are people living in the sites identified, it is going to adversely impact the tenants during the installations. The tenants have already raised concern regarding the impact it would have on the structure and safety of the building. They have existing grievances regarding the quality of the building and the maintenance work done. Their grievances are likely to increase during the construction due to different impacts highlighted above. And it is

important to address this in a systematic manner and provide clear information to the tenants about the project and its work schedule.

Another issue raised was regarding the roof ownership. Although roof is owned by HDC at the moment, as per the agreement this ownership will be transferred to the tenants when all tenants of a particular block completes the payments for the apartments. This is due to happen between 10-25 years depending on the tenant agreement. The PPA with STELCO and the lease agreements with HDC should address this potential legal issue.

On the positive side, local contractors will be used during the installation. Although this will be during the construction period, this will provide temporary job opportunities.

6.2 Management Plan

As described above the expected environmental impact due to the project is minimal. But due to the social issues identified, it is important to manage these issues tactfully. The following management plan is to ensure that the impact remains minimal. The plan is divided into 3 parts, which are;

1. Plan for impacts pre-construction phase
2. Plan for impacts during the construction phase
3. Plan for impacts after the construction (long term impacts)



Mitigation Action	Impact of mitigation	Responsible party	Approx. cost (USD)
<u>Pre- construction phase</u>			
Ensure suppliers comply with ISO or other best practice standard	Minimize emission in supply chain and provides appropriate information required for waste and pollution management	Contractor	N/A
Conduct a structural assessment of selected buildings	Help reduce social grievances as well as ensure safety of tenants and workers alike	Contractor	15,000
Wide dissemination of information of the project and associated grievance redress mechanism and community consultation	Help reduce social conflict and ensure positive economic and livelihood impacts	MEE/HDC/Contractor	500
Avoid roof slopes that could reflect light to neighbor's door, window or balcony.	Help reduce social conflict and heat and light reflection	Contractor	N/A
<u>During the construction phase</u>			
Undertake installation activities during daytime	Minimize the impact of noise and emissions from project implementation. Increases safety	Contractor	N/A
Install screens where appropriate to prevent light reflection to neighbors window, door and balcony	Minimize light and heat pollution.	Contractor	Included in the contract
Disseminate information about work schedule and grievance redress mechanism	Reduce noise, social conflict and ensure safety	MEE/HDC/Contractor	500
Display on site the contact details of the focal point for the grievance redress mechanism	To reduce social conflict	Contractor	N/A
Implement safety measures for high rise installation, which includes safety nets to prevent falling debris, appropriate warning signs and use of all necessary protective gears at all times	Ensure health and safety	Contractor	Included in the contract

Environment Management Plan for Installation of 1.5 MW Rooftop Solar Photovoltaic System in Hulhumale’

Dispose waste generated to an approved waste management site at Hulhumale (Hulhumale Waste management site). The waste from the packaging and construction waste must be treated separately from the domestic waste generated by the workers.	Reduce waste and pollution	Contractor	Included in the contract
<i>After the construction (operation and maintenance)</i>			
Undertake maintenance activities during daytime	Minimize the impact of noise and emissions from project implementation. Increases safety	Contractor	Included in the contract
Install screens where appropriate to prevent light reflection to neighbors window, door and balcony if a new building comes up during its operation	Minimize light and heat pollution.	Contractor	
Disseminate information grievance redress mechanism including displaying the contact details of the focal point on site	Reduce social conflict	MEE/HDC/Contractor	500
Implement safety measures for high rise work during maintenance, which includes safety nets to prevent falling debris, appropriate warning signs and use of all necessary protective gears at all times	Ensure health and safety	Contractor	Included in the contract
Dissemination of information on project performance (e.g. electricity produced via PV and avoided emissions)	Positive impact on economy and livelihood	MEE	N/A
Have storage facility decommissioned solar PV and establish ways to either recycle or safely dispose of the waste	Reduce waste and pollution	Contractor	Included in the contract

6.3 Monitoring Plan

In order to ensure the suggested management plan is undertaken and the objectives of the project is being achieved, the contractor is to devise and follow a monitoring plan. Following table is the suggested monitoring plan identifying the indicators to measure and the frequency at which monitoring activity has to be undertaken.

Impact	Indicator	Source of Information	Monitoring Frequency
Air Emissions	Reduction in greenhouse gas emissions caused by the project	STELCO	Monthly / Annual after commissioning
Noise Emissions	Noise intensity and duration during implementation	Contractor, Third Party Monitoring	Daily during implementation
Heat or Light reflection	Number of complaints on heat and light reflection	Contractor	On complaint basis
Chemicals	Details on the type and number of PV by manufacturer and supplier	Contractor	Once before the mobilizing
Health and safety	Reports of occupational health injuries and accidents or any infringement to on occupational health rules and regulations or policy	Contractor	Daily during implementation and whenever maintenance is under taken
Waste Management	Quantity of waste produced and taken to waste management site	Contractor	Daily during implementation
Social impacts	Number of grievances lodged	Contractor	Daily during implementation and on request-basis during operation

7 Grievance Mechanism

Should there be cases for grievance, a potential grievance mechanism is suggested as follows. This includes 3 tiers of addressing the grievances. Every effort shall be given to find an amicable solution before higher tiers could be engaged. The following should be facilitated to the stakeholders (tenant, community or general public) by HDC and MEE.

- An information board providing the contact details must be made available at the HDC office.
- **Tier I, II and III Complaint Forms** must be available online through the MEE and HDC websites in addition to the hard copies from the HDC office. (The form will be prepared, produced and supplied to the HDC by MEE.)
- A register of list of grievances classified as ASPIRE programme related must be maintained. The register should include informally communicated grievances maintained by HDC in collaboration with MEE.

7.1 First Tier

Focal point: Personnel with authority appointed within HDC

- Grievances can be registered formally by contacting the HDC (directed to the contact person(s)). A copy of the application form must be provided as a receipt.
- The application must be screened by HDC to determine if the issues and concerns raised in the complaint falls within the mandate of the ASPIRE program. A solution will be determined by the HDC through one of the procedures:
 - Internal discussion within HDC decision making process
 - Through negotiations with the aggrieved party
 - Combination of both options
- A written notification will be provided to the aggrieved party if a solution is reached within working 7 days.
- An acknowledgment of the receipt of the decision of HDC and acceptance or denial of the decision by HDC must be provided by the aggrieved party within 10 days. If no acknowledgement is submitted from the aggrieved party then the decision will be considered as accepted.

7.2 Second Tier

Focal Point: ASPIRE MEE

- If no solution was reached and the grievance cannot be resolved by the Tier I process, the aggrieved party can elevate the grievance to Tier II. The **Tier II Complaint Form** must be submitted to MEE with a copy of Tier I application form and the decision of HDC from the Tier I process. MEE will forward the matter to an appointed focal point.
- The application will be screened to determine if it is related to the ASPIRE projects.
- If MEE finds that the application is not related, the aggrieved party must be notified in writing with a way forwarded including the necessary government institutions to follow up with.
- If MEE finds the application is related, MEE must arrange a meeting and notify the meeting venue and time to the aggrieved party to start the discussion on Tier II process.
- If necessary MEE may also invite HDC to the meeting or visit the site to conduct the meetings.
- The MEE will be responsible to ensure that there is no cost imposed on the aggrieved person, due to the grievance mechanism at the second tier.
- A written notification by MEE will be provided to the aggrieved party if a solution is reached within working 15 days.
An acknowledgment of the receipt of the decision of MEE and acceptance or denial of the decision by MEE must be provided by the aggrieved party within 10 days. If no acknowledgement is submitted from the aggrieved party then the decision will be considered as accepted.
If not satisfactory solution was reached through the Tier II process, the aggrieved party may notify the MEE, in writing of the intention to move to Tier III.

7.3 Third Tier

Focal Point: Judiciary (Court)

- At the Tier III level, the national legal system is accessible to all aggrieved parties.
- All the privileges liable through the legal system could be used by the aggrieved parties.
- The verdict of the Courts will be final.

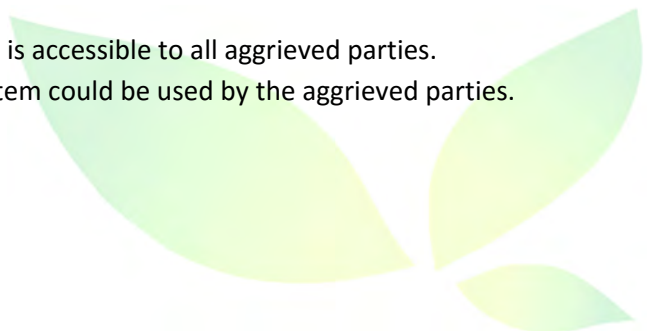

8 Consultants Declaration

I hereby certify that the information provided in this Environment Management Plan (EMP) are true, complete and correct to the best of my knowledge.

Name: Ali Shareef (EIA consultant 19/11)

Signature:

Date: 4 April 2016



9 Community consultations

A community consultation was carried out by the MEE, the project management unit and the HDC. Letters were sent out to all the tenants asking to lodge any complaints they have. Among the letters received, 9 letters were for objection. Individual consultations were carried with the tenants who objected to clear out their concerns and explain in detail of the benefits of the project. Most of the concerns were due to the existing situation of the building (cracks in some of the places) and on the promptness of attendance to maintenance. Some of them had concerns that the existing problem might get worse if the issues are not addressed before the project begins. This indicates that a proper grievance mechanism must be in place should there be a case.

A summary of complains received by the tenants are as below.

Tenant Block Number	Complaint
105	Building is of low quality and extra PV modules might cause exacerbate the problems.
108, 122	Asked for additional detailed information.
123	The project might cause extra damage and did not get an opportunity to install own PV system.
	Concerned about having allergies. Got medical information that modules used in PV systems have substances harmful to health.
126	Had bad experiences with the HDC regarding maintenance of the building and reluctant to give approval for the project.
90	Previously had bad experiences with maintenance and repair and cannot give time for extra maintenance such as ceiling cracks.
101	If the contractor or anyone else is liable for any damages then willing to give no objection.
101	Concerned about who will be responsible for any damages to furniture of electronics or any damage to property.



10 Implementation Plan



Method statement – Substructure and module mounting

Technical description

- PV modules will be mounted on substructure in portrait orientation (bottom side of the module facing towards lower edge of the roof) using mounting clamps.
- Substructure crossbars will be made of aluminium and will have a height of ~60 mm in order to allow ventilation of PV modules (see figure 1).
- Mounting clamps (see figure 2 and 3) will be made of aluminium and will have a height matching requirements due to module frame dimensions.
- Substructure crossbars will be mounted on raised bead of tin roofs using rubber buffers and sealing rivets in order to prevent corrosion of existing tin roofs and water seepage (see figures 1, 4 and 5).
- Each substructure crossbar will be mounted on two raised bead of the tin roofs only. This will avoid damages to tin roofs or substructure due to different expansion coefficients of steel plate tin roof and aluminium substructure crossbars. Resulting length of substructure crossbars is ~460 mm each, which equals distance between two raised beads plus 50 mm on each end as additional mounting space (see figure 6).
- All cables will be attached to substructure crossbars cable ties in order to prevent sags into deep corrugation spaces as well as contact with tin roof sheets in general. Wherever potentially exposed to sunlight/UV radiation, cables will be guided and covered using cable ducts or protective and UV resistant pipes.
- Installed PV unit will look similar to example PV installations as per figures 6 and 7.

Illustrative pictures

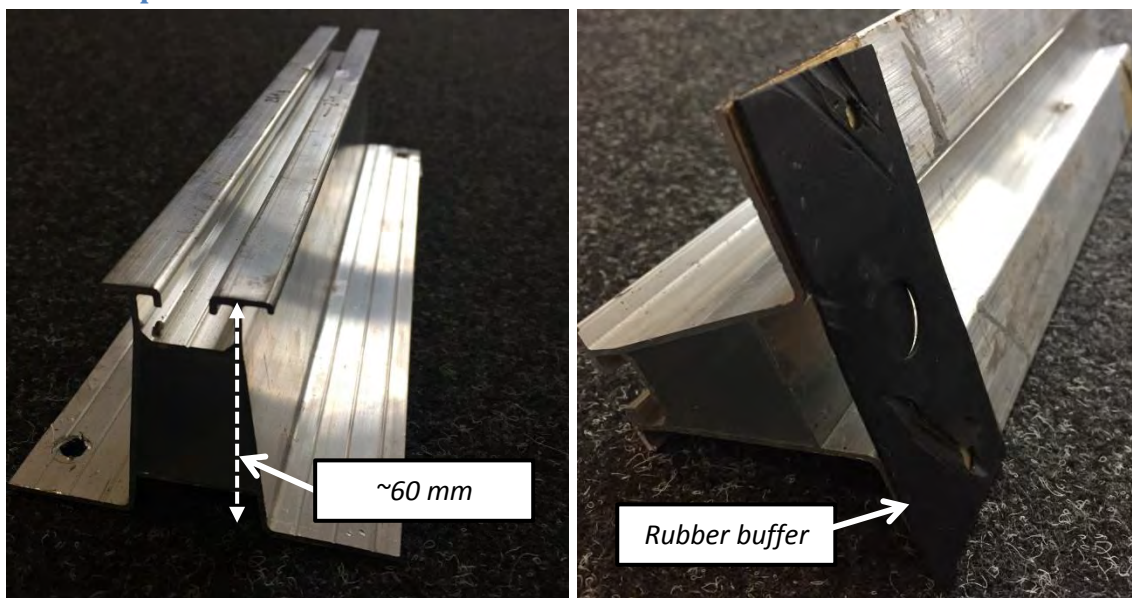

Figure 1: Substructure crossbar with rubber buffer

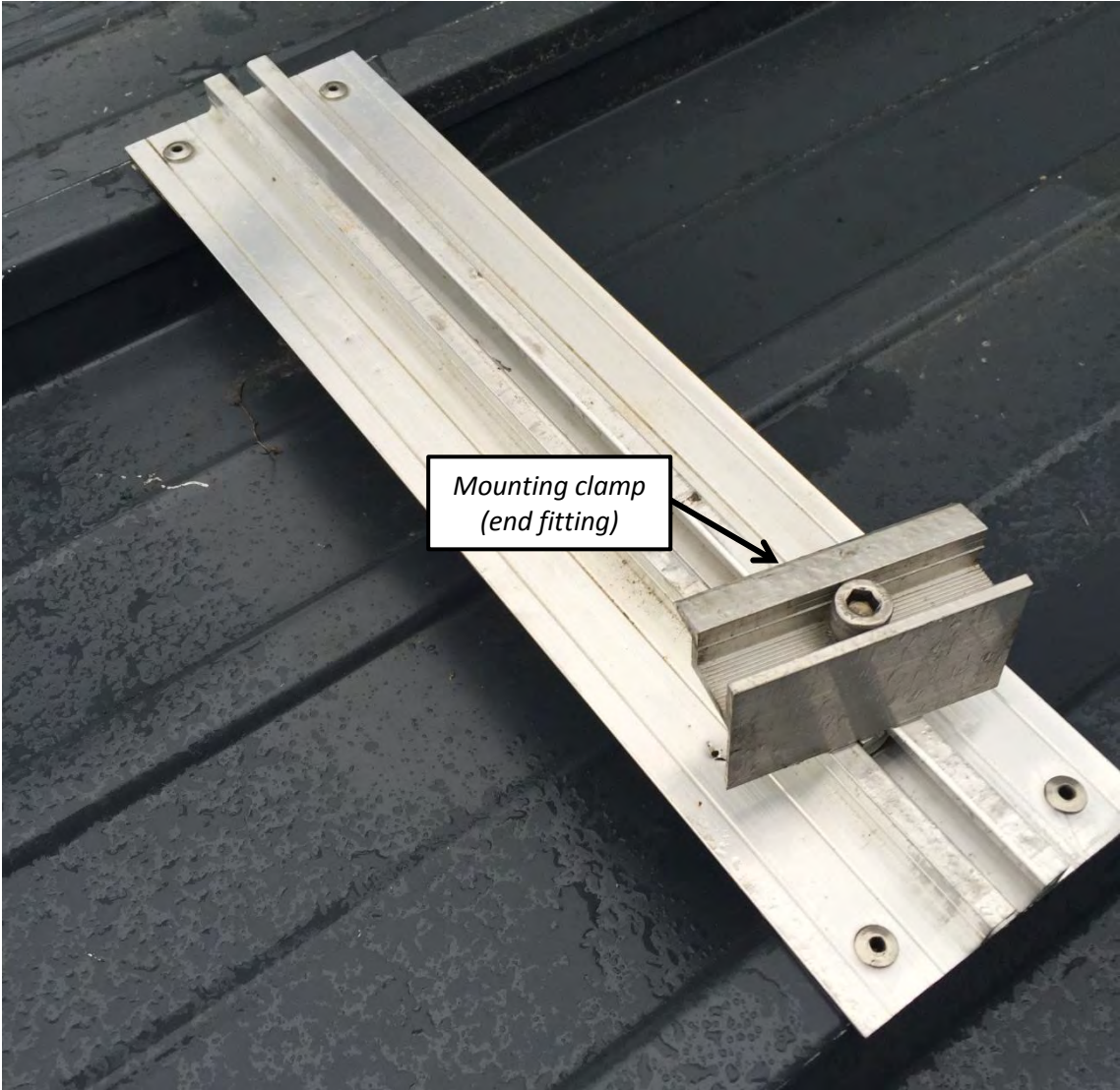

Figure 2: Example substructure crossbar with mounting clamp (end fitting)

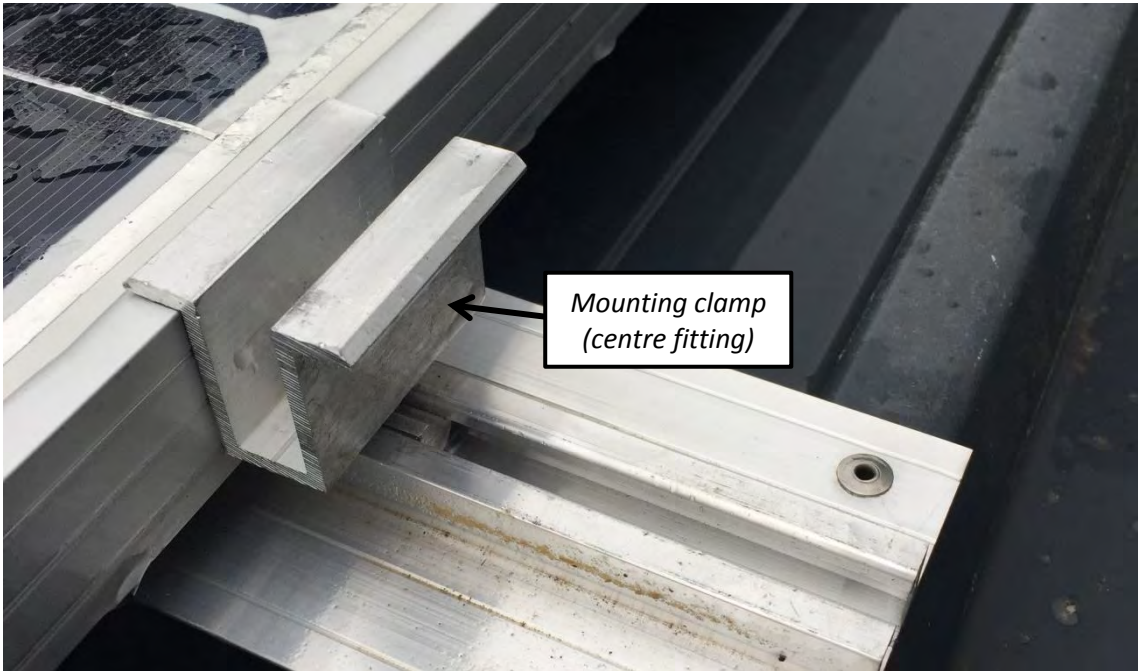

Figure 3: Example substructure crossbar with mounting clamp (centre fitting) and PV module

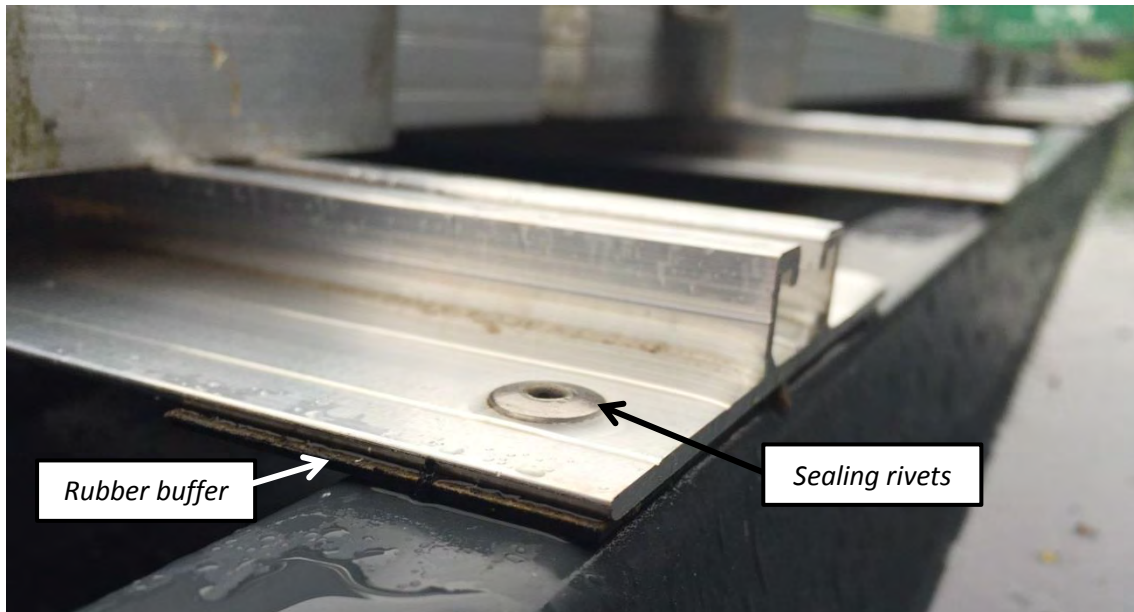

Figure 4: Example substructure crossbar with rubber buffers and sealing rivets

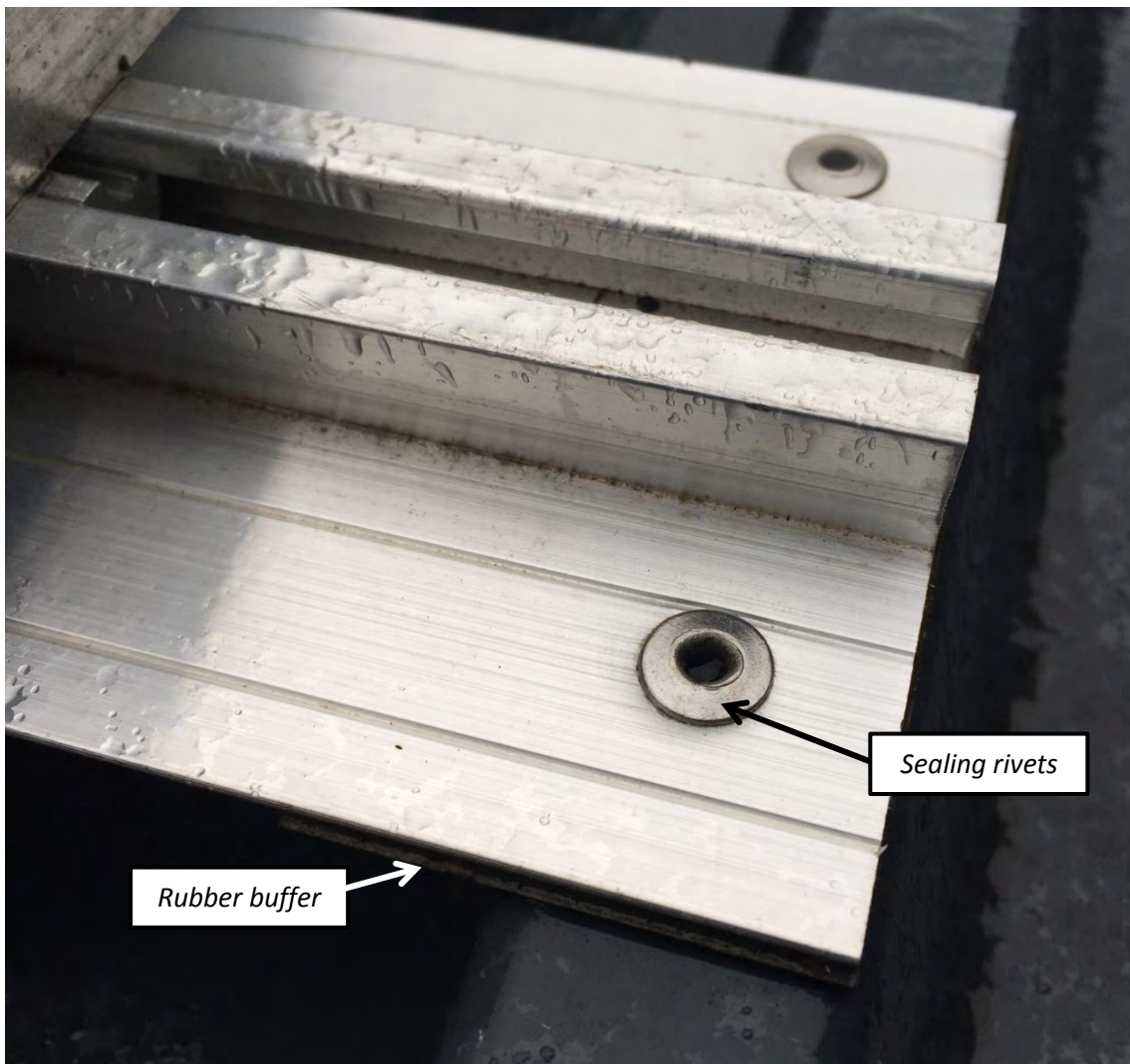

Figure 5: Example substructure crossbar with rubber buffers and sealing rivets



Figure 6: Example substructure crossbar with mounting clamp (centre fitting) and PV module



Figure 7: Example substructure crossbar with mounting clamp (end fitting) and PV modules



Figure 8: Substructure crossbar with PV modules

Steps of procedure

Preparation and Planning

1. Exact measuring of roof area
2. Measuring of cable runs and connection point
3. Planning and preparation of layouts

Site setup and equipment

4. Setup of construction site incl. arranging of temporary service and storage area
5. Establishing of roof access
6. Setup of guard rail
7. Documentation of existing roof damages

Roof-top construction works

8. Measuring of positions on the roof
9. Preparation of substructure
10. Installation of substructure
11. Installation of DC cables to inverter
12. Installation of connectors to the DC cabling
13. Installation of solar panels

Ground floor construction works

14. Installation of Inverters
15. Connection of DC cables to inverters
16. Installation of AC cables

Tests and commissioning

17. Testing and preparation of measuring protocols
18. Installation, connection, and implementation of monitoring system
19. Commissioning of the solar power system
20. Final acceptance

Technical description and method statement

Technical description

- PV power plant parts will be installed on '1000 housings' '2 and 3 unit type' buildings only
- PV power plant facilities will be planned and built in standardised, equally sized units
- One PV power plant unit ('PV unit') will be installed per housing unit (2 PV units for '2 unit type' houses, 3 PV units for '3 unit type' houses)
- Preliminary components and sizing
 - Module 250W; framed glas-glas modules
 - Inverter Sungrow SG20KTL
 - PV unit 3 strings; 24 modules per string; nominal DC power: 18 kW
- Inverters and metering equipment will be installed in entrance areas of '1000 housing' buildings
- Grid connection will be conducted at building connection lines for each individual unit.
Building connection lines are connected to substations 19 and 28, which provide a total power of 1630 kVA.

PV power plant equipment

- 83 PV units (1,494 kW DC) installed on 13 '3 unit type' and 22 '2 unit type' buildings
- 5976 modules (72 per PV unit)
- 83 inverters (one per PV unit)
- 83 electric meters (one per PV unit)
- 35 monitoring units incl. modems (one per building)

Installation procedure

- Detailed measuring of roof areas Gräss, MV
- Detailed measuring of cable runs for DC, AC, monitoring, and grounding cables Gräss, MV
- Survey of site conditions regarding potential interconnection between houses with CAT7 or fibre optic cables. If interconnection would be possible with reasonable effort, number of monitoring units and modems could be reduced Gräss, MV
- Detailed planning of PV units, cable runs, etc. Gräss, CH
- Inspection of planning documents and layout; adjustment of planning documents according to Maldives requirements, if required; pre-approval of planning documents; forwarding of planning documents to governmental agencies local contractor, MV
- Manufacturing and preparation of substructure (cutting to length, application of adhesive sealing tape, pre-assembly, etc.) Gräss, CH
- Delivery of substructure, cables, mounting equipment (e.g. module clamps), small parts, etc. Gräss, CH to MV
- Delivery of required machinery and power tools Gräss, CH to MV
- Delivery of security equipment (e.g. anti-fall guard) Gräss, CH to MV
- Set-up of sites incl. temporary power service, secure storage area, waste management, etc. Gräss, MV
- Delivery of modules CMEC, CN to MV
- Delivery of inverters Sungrow, CN to MV
- Delivery of monitoring units and further electrical equipment Gräss, CH to MV
- Delivery of protective equipment (steel frame with perforated sheets; for inverters, electric metering, and monitoring equipment) Gräss, MV



- Individual installation per building/PV unit *as described below*
- Teardown and clearing of temporary construction compounds Gräss, MV

Installation procedure per building/PV unit

- Set-up of stair tower and skip hoist for roof access Gräss, MV
- Set-up of anti-fall guard Gräss, MV
- Preparation of report of previous/existing roof damages (incl. photo documentation) Gräss, MV
- Measuring of positions for substructure installation Gräss, MV
- Installation of substructure Gräss, MV
- Installation of cable ducts (roof to inverters) Gräss, MV
- Installation of DC cables (roof to inverters) incl. mounting of cable connectors Gräss, MV
- Installation of monitoring cables (inverter to inverter via roof) Gräss, MV
- Installation of grounding cables (roof to ground, inverters, to ground) and ground rod Gräss, MV
- Installation of PV modules (mounting, installation of DC connections) Gräss, MV
- Installation of inverters (mounting, DC connection) Gräss, MV
- Installation of protective equipment (for inverters etc.) Gräss, MV
- Installation of metering equipment (mounting, inverter connection, grid connection) Gräss, MV
- Preparation of measuring reports/test records for each PV unit as well as for the whole plant Gräss, MV
- Installation of monitoring units (mounting, cable connections, initial operation) Gräss, MV
- Initial operation of PV unit Gräss, MV
- Final inspection and acceptance of PV units Gräss and local contractor, MV

Maldives Tender (1.5 MW Hulhumalé)
Preliminary construction schedule

Date	week 26 27.06.2016	week 27 04.07.2016	week 28 11.07.2016	week 29 18.07.2016	week 30 25.07.2016	week 31 01.08.2016	week 32 08.08.2016	week 33 15.08.2016
Construction supervisor								
Team 1	3 unit type	3 unit type	3 unit type	3 unit type	3 unit type	3 unit type	2 unit type	2 u.
Team 2	3 unit type	3 unit type	3 unit type	3 unit type	3 unit type	2 unit type	2 unit type	2 unit
Team 3	3 unit type	3 unit type	3 unit type	3 unit type	3 unit type	2 unit type	2 unit type	2 unit

Date	week 34 22.08.2016	week 35 29.08.2016	week 36 05.09.2016	week 37 12.09.2016	week 38 19.09.2016	week 39 26.09.2016
Construction supervisor						
Team 1	2 unit	2 unit type	2 unit type	2 unit type	2 unit type	Comissioning and tests
Team 2	2 u.	2 unit type	2 unit type	2 unit type	2 unit type	
Team 3	2 u.	2 unit type	2 unit type	2 unit type	2 unit type	

Construction supervisor will be Gräss personnel.
 Each team will consist of one foreman and two workers. Foreman will be Gräss personnel, workers will be local employees.

11 Layout Drawings

Description of system layout/operational principle

Main PV power plant equipment

- 82 PV units installed on 8 '3 unit type' and 29 '2 unit type' buildings
- 6,150 PV modules (75 per PV unit)
- 82 inverters (one per PV unit)
- 82 electric meters (one per PV unit)
- 37 monitoring units incl. modems (one per building)

Main components for one PV unit

- 75 PV modules will be installed on roof
- 25 PV modules will be connected to form one strings (done three times)
- 3 strings will be connected to one inverter
- One inverter will be connected to public grid via one electric meter, which measures energy feed into public grid
- All inverters within one building will be connected to one Monitoring unit incl. modem
- Monitoring units are connected to the internet to enable supervision by any authorised person or authority such as STELCO offices and/or power plants.

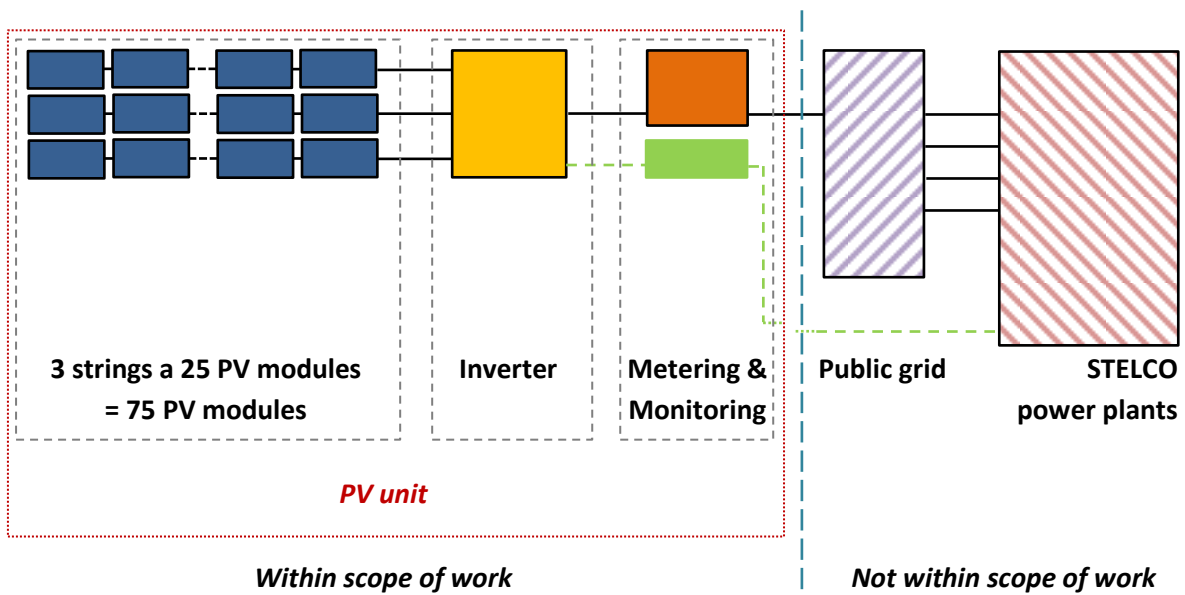

Roof space

	2 unit type	3 unit type
Available roof space	~330 m ²	~493 m ²
Used roof space	~238 m ²	~357 m ²
Roof consumption	~72%	~72%

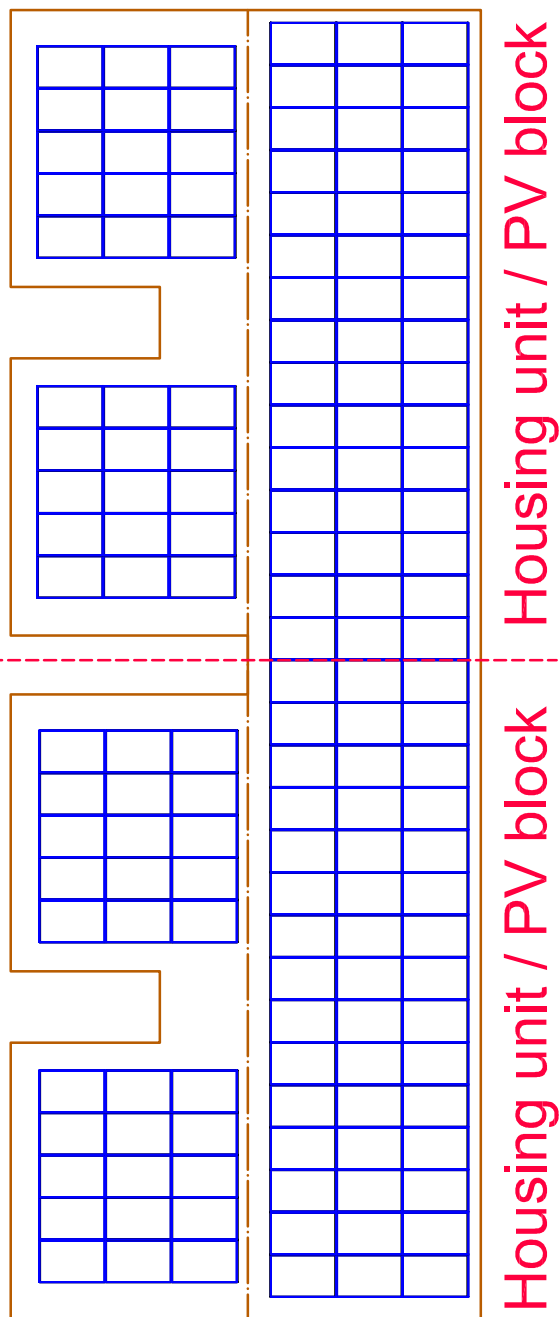

2 unit type house

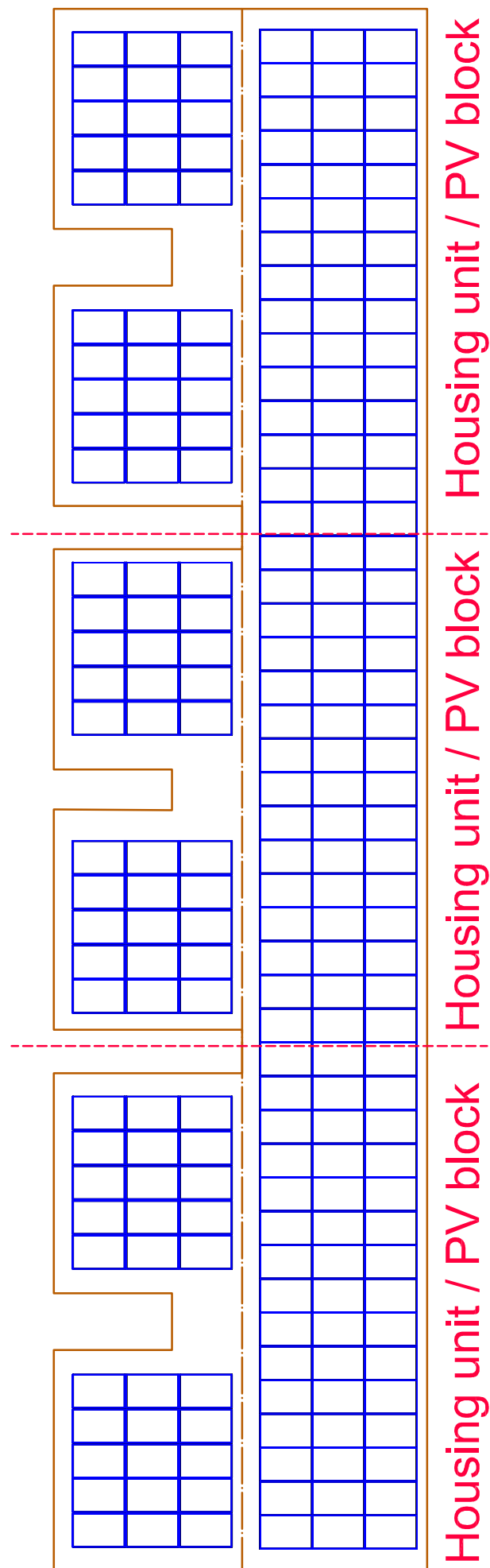

3 unit type house

Housing unit / PV block

- 75 PV modules
- One PV inverter
- Monitoring equipment
- Electric meter
- Backup meter

PV inverter

- Make: Sungrow
- Model: SG20KTL
- Type: String inverter; transformerless
- Power: 20.0 kW
- Origin: China

PV modules

- Type: Glass-glass laminated
- Power: 260 Wp

2015			 we build energy.	
changed:	date	name	Project: Hulhumale Tender	
changed:	03.03.16	ME	Hulhumale, Maldives	
drawer:	14.12.12	ME	Designation: Roof layout	
Scale: none			1000 housing 2/3 unit type	
Total Power			Status	
1,599.00 kWp			drawing number	
Hulhumale_roofs_new.dwg			paper size	
03.03.2016			Draft	
			16-02-HUMA-002	
			A3	

PV rooftop installations

Unit type	Amount	Rated power
-----------	--------	-------------

Northern section

2 unit	4	156.0 kWp
3 unit	6	351.0 kWp

Central section

2 unit	7	273.0 kWp
--------	---	-----------

Southern section

2 unit	18	702.0 kWp
3 unit	2	117.0 kWp

Total

2 unit	29	1,131.0 kWp
3 unit	8	468.0 kWp
Total		1,599.0 kWp



PROJECT : ASPIRE

DRAWING : LOCATION MAP

GRASS
we build energy.

2016	date	name	Project:	Hulhumale Tender Hulhumale, Maldives	
changed:	31.03.16	ME			
changed:	26.01.16	ME			
drawer:	14.12.15	ME	Designation:	General layout Use of 1000 housing units	
Scale:	none				
Total Power 1,599.00 kWp			Status	drawing number	paper size
Hulhumale_distribution_network.dwg 31.03.2016			Draft	16-02-HUMA-001	A3

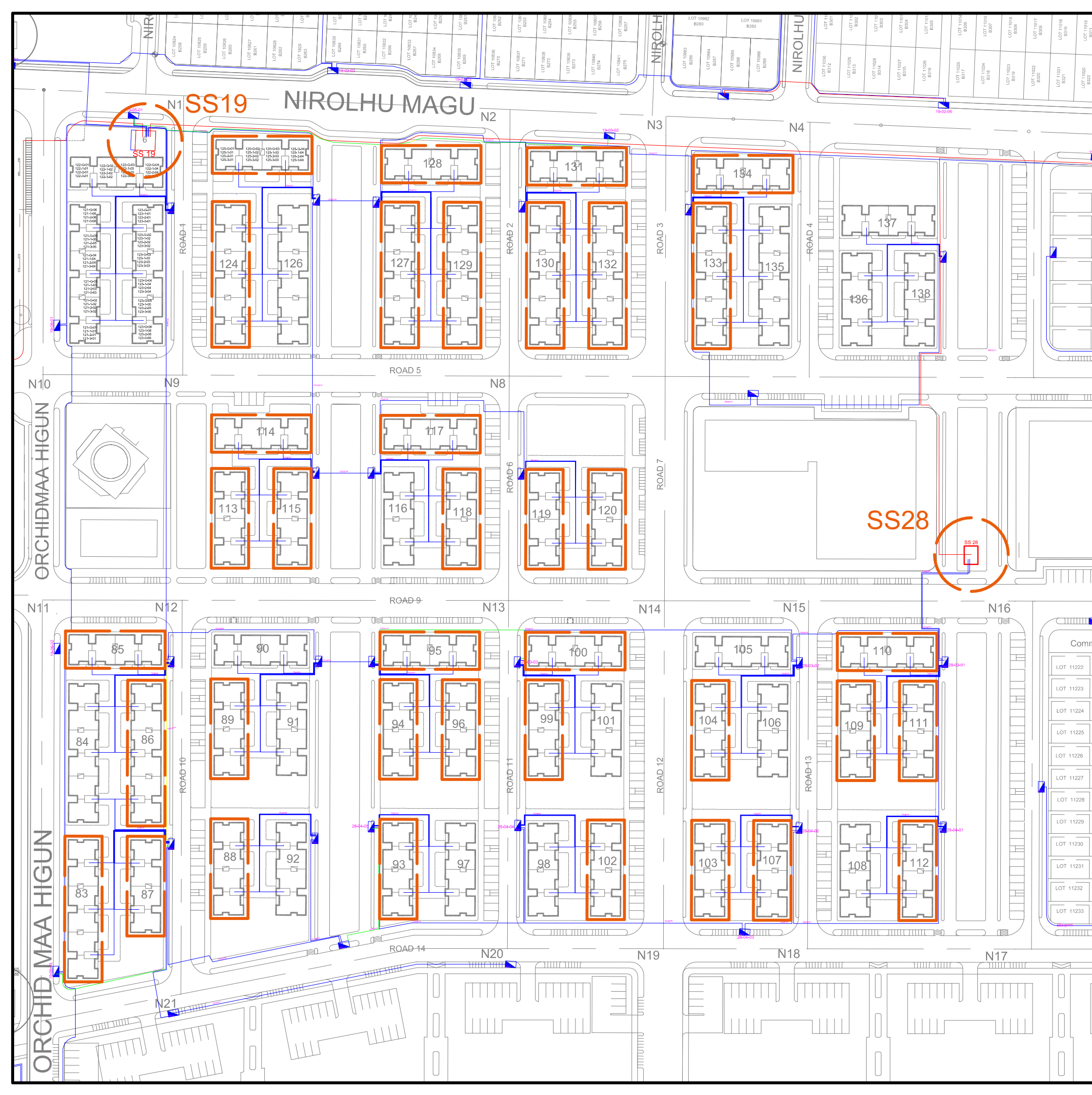

1000 housing buildings, 3 unit type

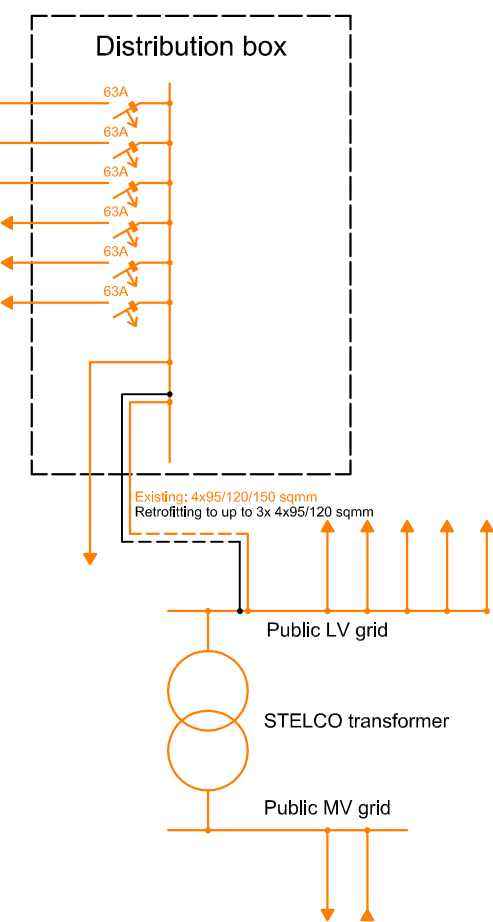
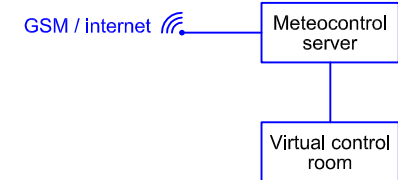
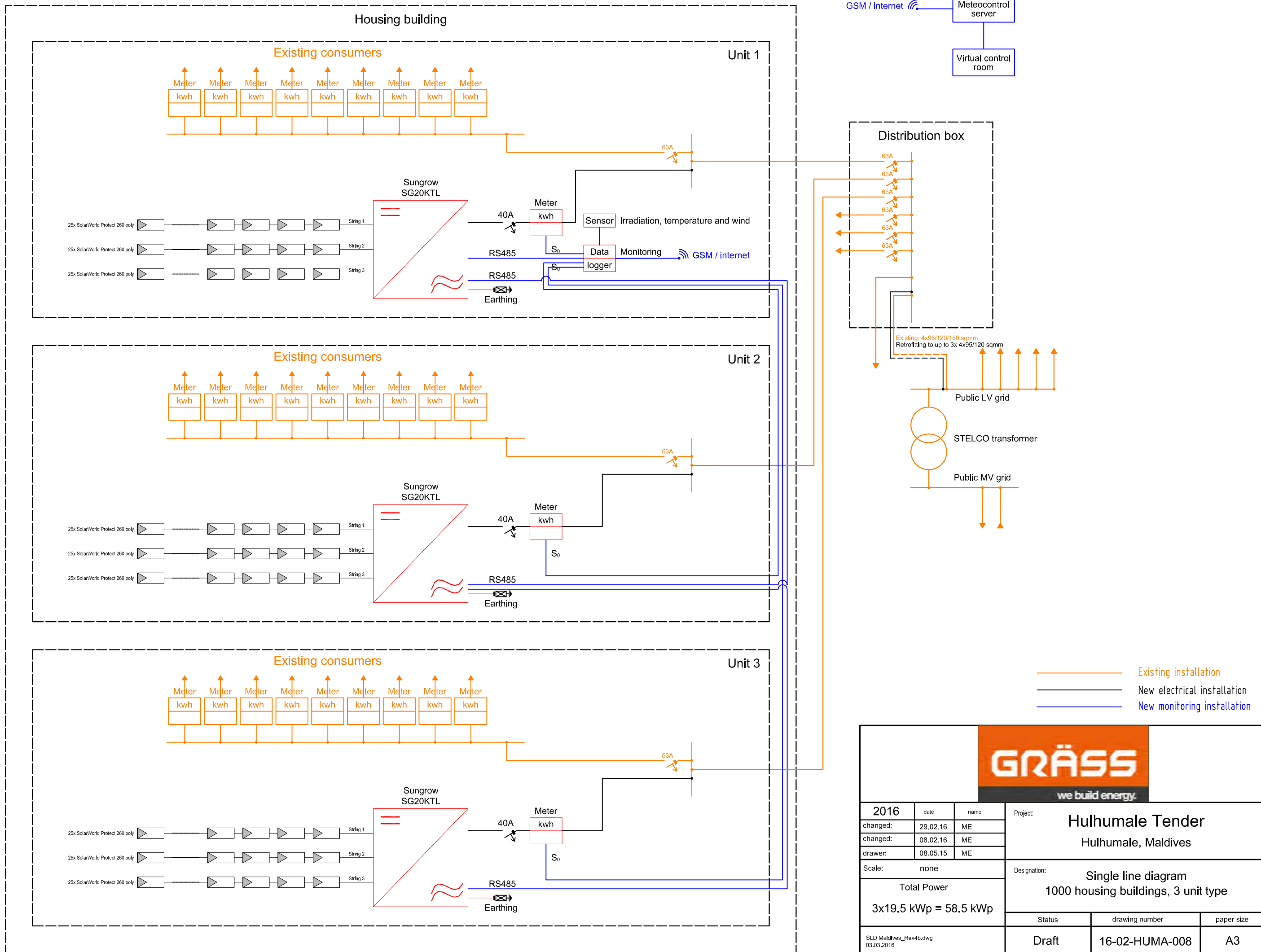

— Existing installation
— New electrical installation
— New monitoring installation

GRÄSS we build energy.			Project: Hulhumale Tender Hulhumale, Maldives		
2016	date	name			
changed:	29.02.16	ME			
changed:	08.02.16	ME			
drawer:	08.05.15	ME	Status: Draft drawing number: 16-02-HUMA-008 paper size: A3		
Scale:	none				
Total Power 3x19.5 kWp = 58.5 kWp			SLD Maldives_Rev4b.dwg 03.03.2016		
Draft					

1000 housing buildings, 2 unit type

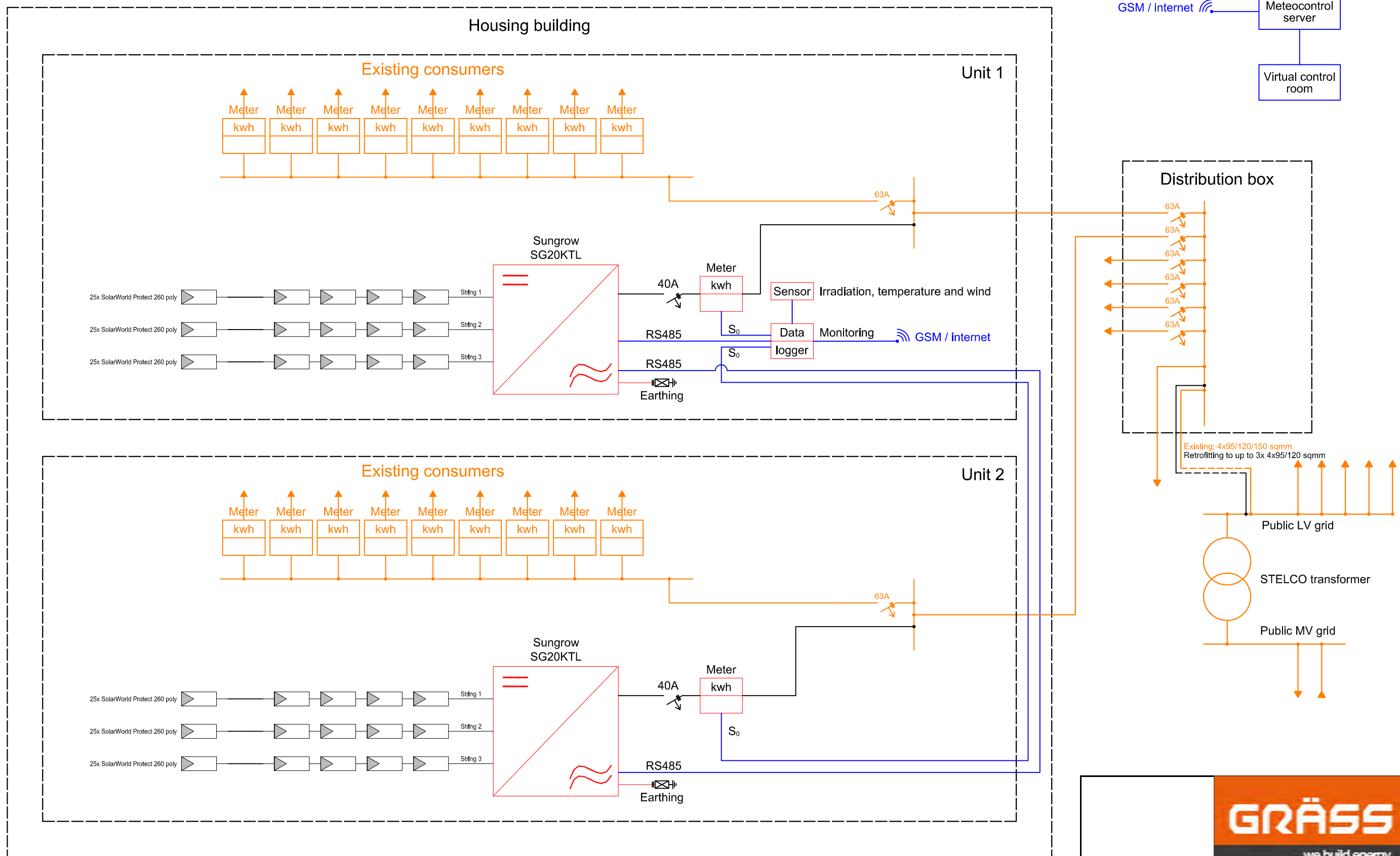

- Existing installation
- New electrical installation
- New monitoring installation

GRÄSS we build energy.			Project: Hulhumale Tender Hulhumale, Maldives		
2016	date	name			
changed:	29.02.16	ME	Designation: Single line diagram 1000 housing buildings, 2 unit type		
changed:	08.02.16	ME			
drawer:	08.05.15	ME			
Scale: none			Status: Draft		
Total Power 2x19.5 kWp = 39 kWp					
SLD Maldives_Rev4b.dwg 03.03.2016			drawing number: 16-02-HUMA-003		paper size: A3