

PROVISION OF WATER SUPPLY SANITATION AND SOLID WASTE MANAGEMENT PROJECT

H.DH NOLHIVARANFARU ISLAND WASTE MANAGEMENT CENTER

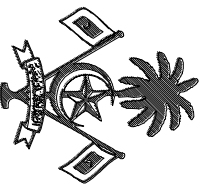

SOLID WASTE MANAGEMENT COMPONENT
OF/D PROJECT
MINISTRY OF ENVIRONMENT AND ENERGY
HANDHUVAREE HINGUN MALE' 20-01
REPUBLIC OF MALDIVES

ACCESS ROAD

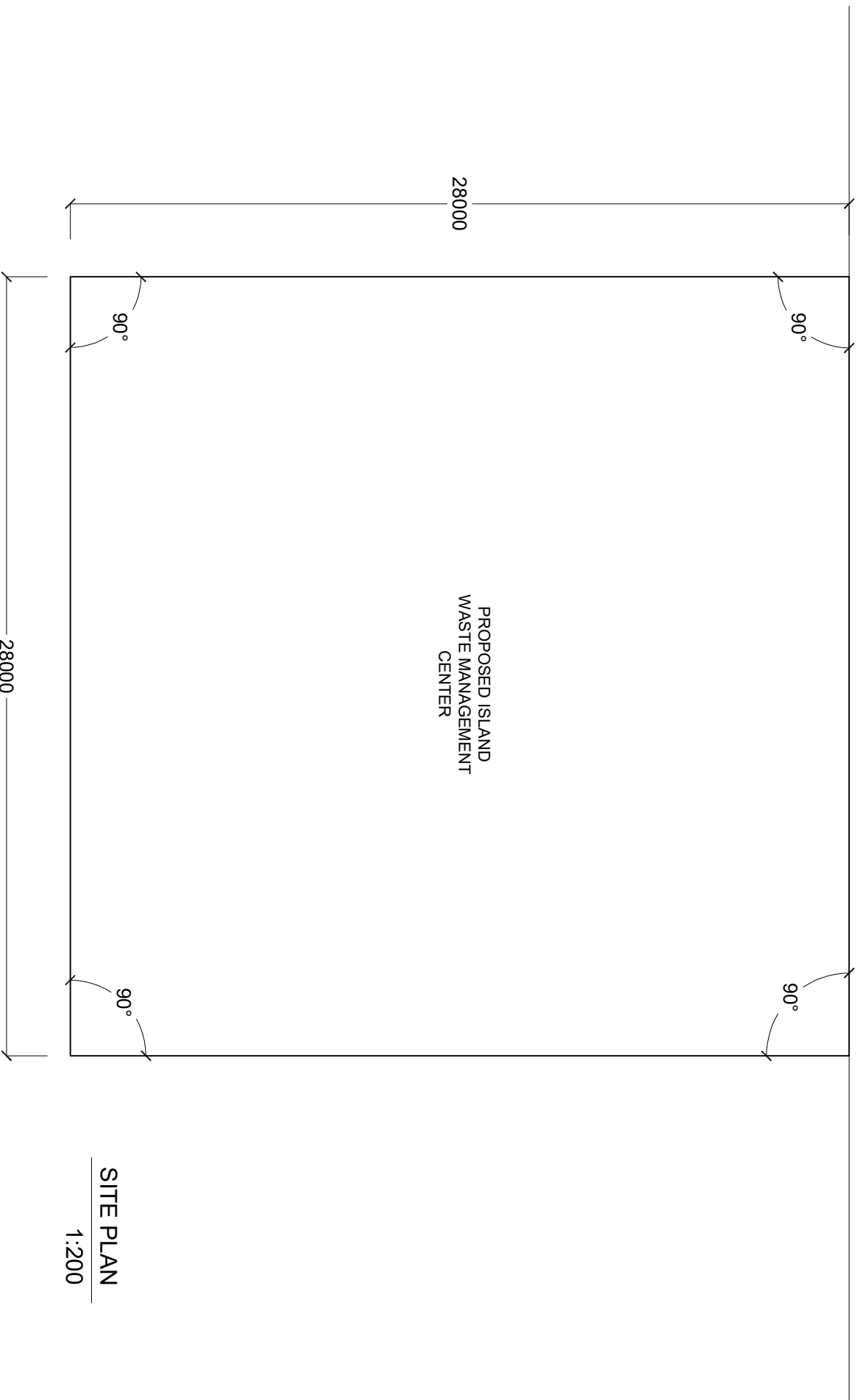

PROPOSED ISLAND
WASTE MANAGEMENT
CENTER

SITE PLAN
1:200

PROVISION OF WATER SUPPLY SANITATION AND SOLID
WASTE MANAGEMENT PROJECT
OPEC FUND FOR INTERNATIONAL DEVELOPMENT

PROJECT:
H/DH NOLHIVARANFARU ISLAND WASTE MANAGEMENT
CENTER

SCALE: AS SHOWN

DATE: JUNE 2017



STATE WATER MANAGEMENT COMMITTEE
MINISTRY OF ENVIRONMENT AND ENERGY
NADWALAH AL-KHAYMA, BAHIG 20-01
19525, SAUDI ARABIA

IWMC LAYOUT
 1:200

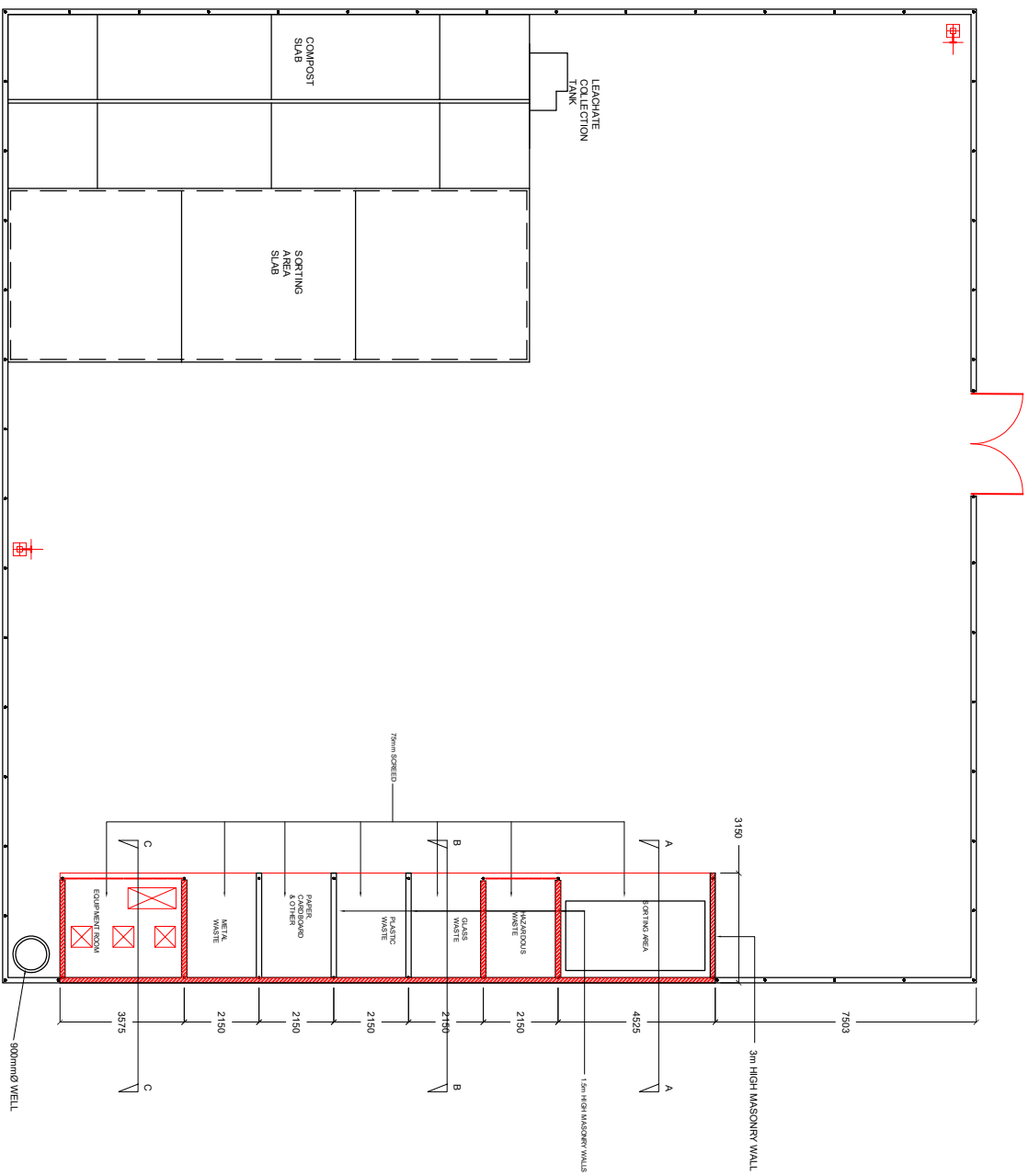

FENCE FOUNDATION AND COLLECTION AREA FOUNDATION
1:200

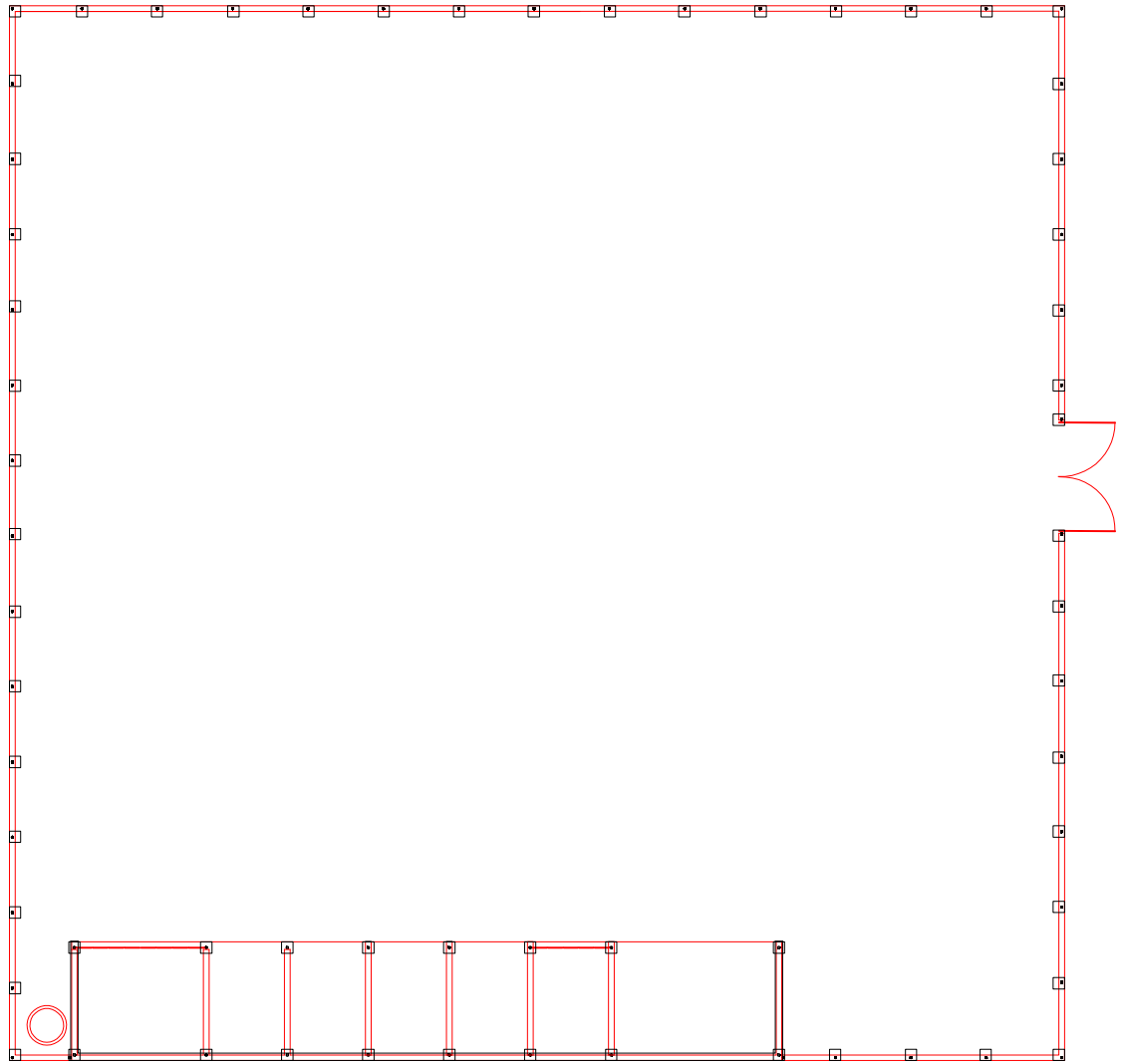

LINE FOOTING FOR 3m HIGH WALL



IWMC LAYOUT
1:200

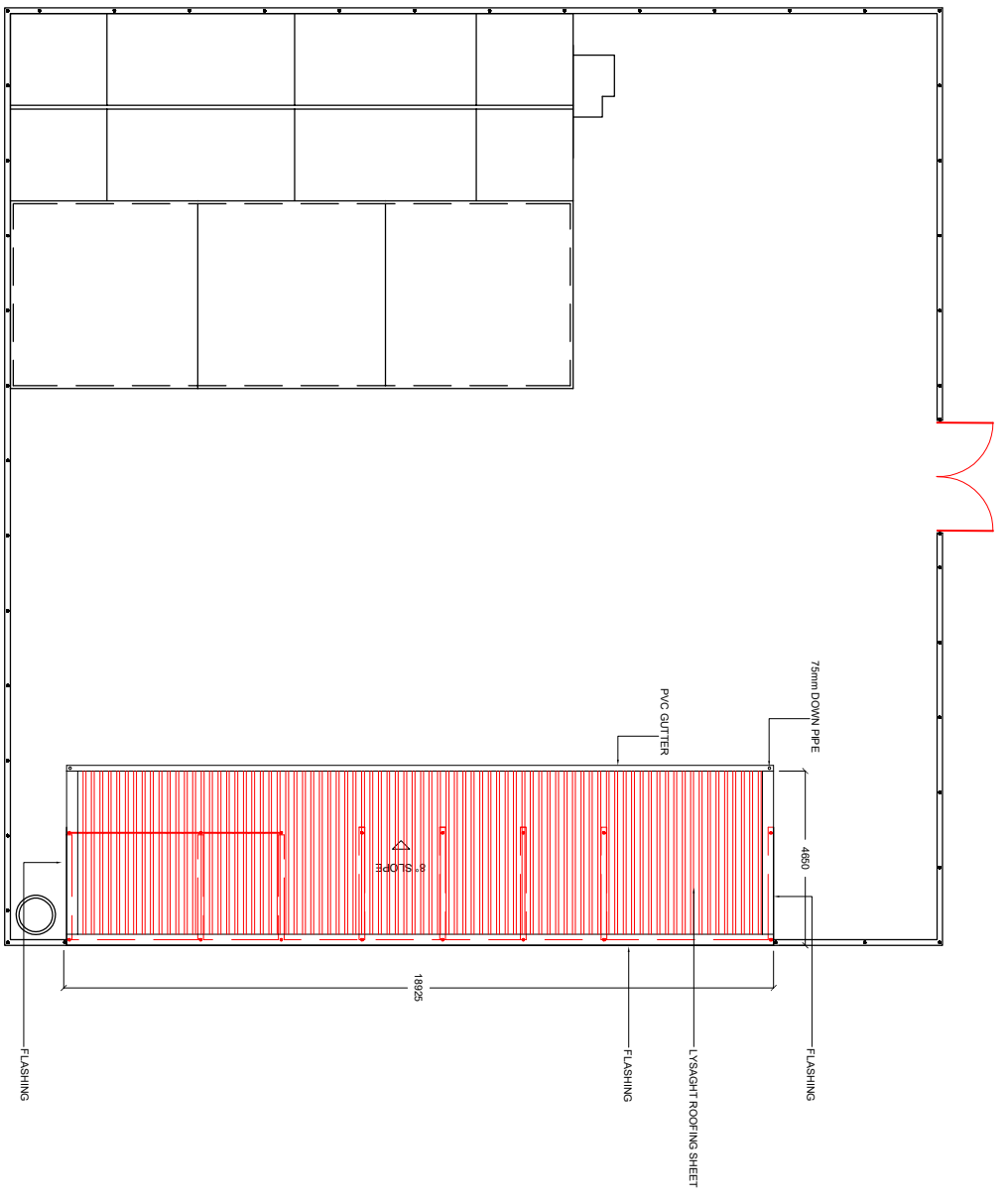

ROOF FRAMING LAYOUT
1:200

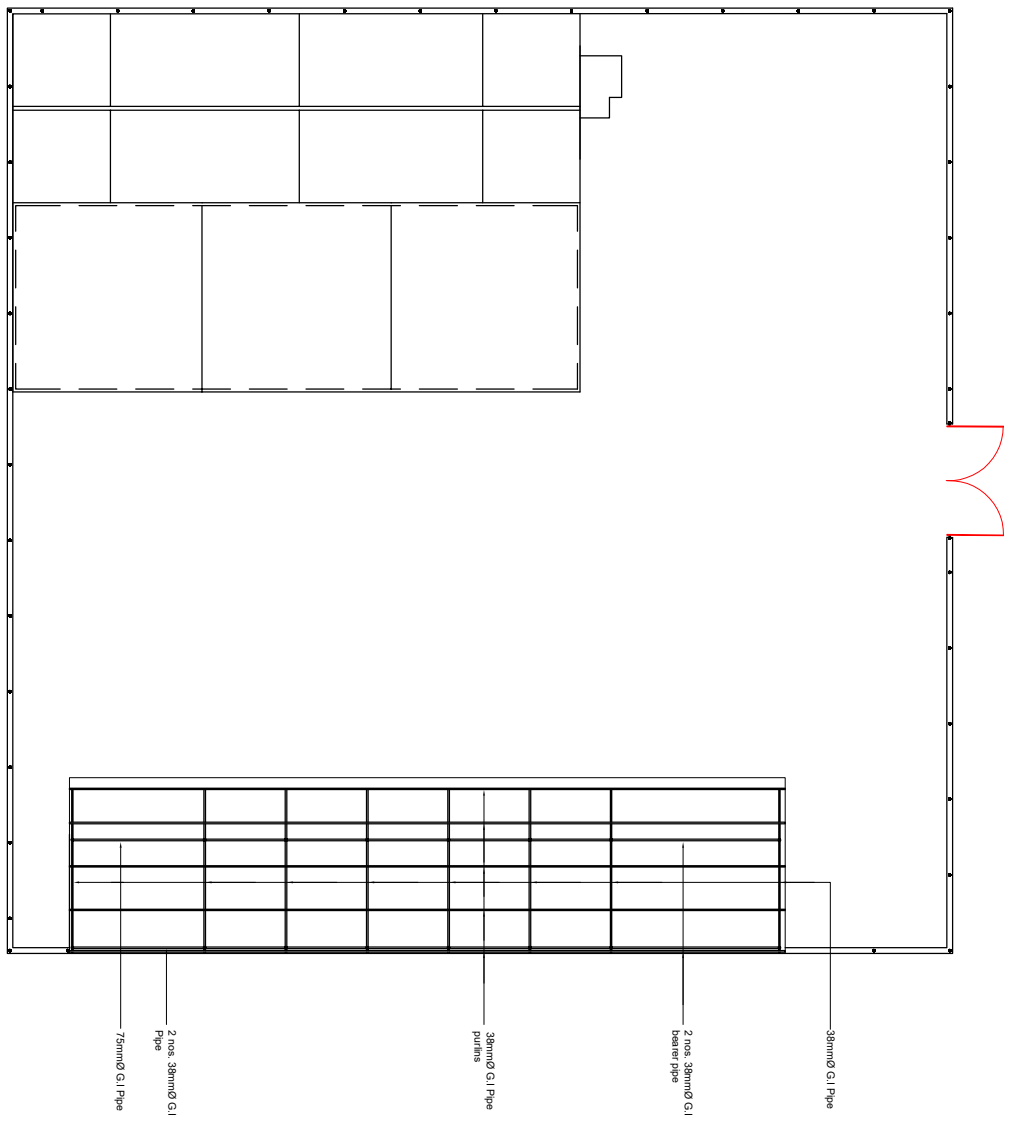

PLUMBING LAYOUT
1:200

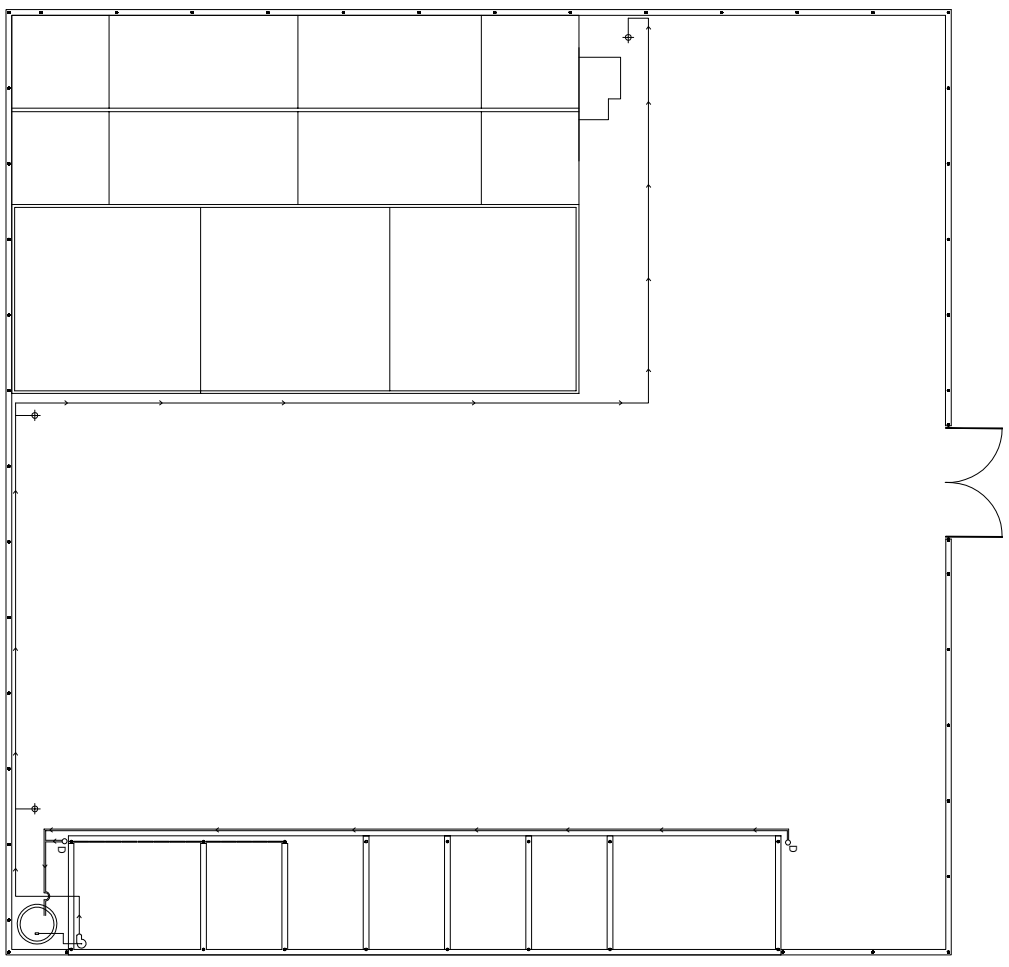

- 75mm Conveyance pipe
- D Down pipe
- Foot valve
- Shallow well pump (230V, 550W)
- ⊕ Metal tap

ELECTRICAL LAYOUT
 1:200

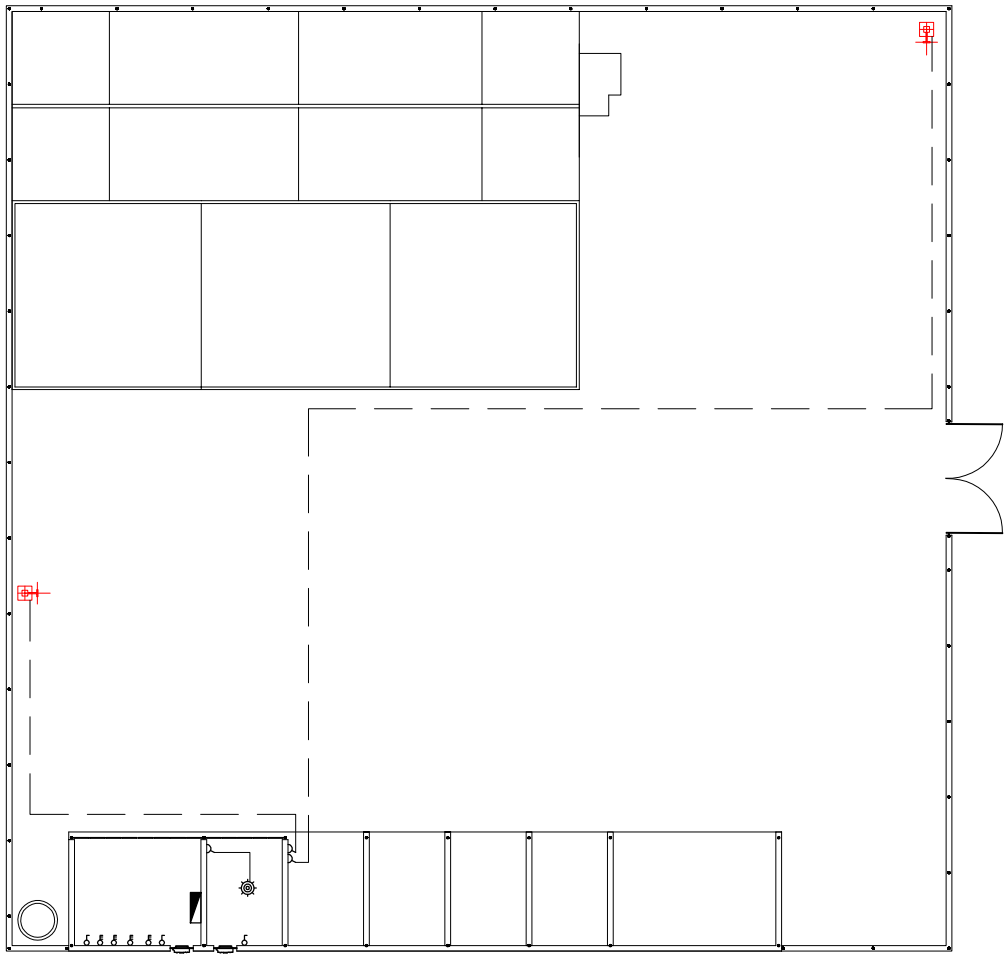

- DISTRIBUTION BOARD
- LOW ENERGY SAVING LIGHT
- 3 PHASE POWER POINTS
 (1.5m ABOVE GROUND)
- 1 PHASE POWER POINTS
 (1.5m ABOVE GROUND)
- WEATHER PROOF SWITCH
- EXHAUST FAN
 (250 W, 230 V)

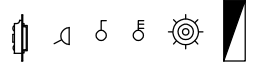

LEACHATE COLLECTION TANK
(900 x 900 x 900)

EXPANSION JOINTS

EXPANSION JOINTS



SLAB TURNED
DOWN BY 300mm

COMPOST SLAB AND SORTING AREA SLAB
1:100

PROVISION OF WATER SUPPLY SANITATION AND SOLID
WASTE MANAGEMENT PROJECT
OPEC FUND FOR INTERNATIONAL DEVELOPMENT

PROJECT:
H1DH NOLHIVARANFARU ISLAND WASTE MANAGEMENT
CENTER

SCALE: AS SHOWN
DATE: JUNE 2017



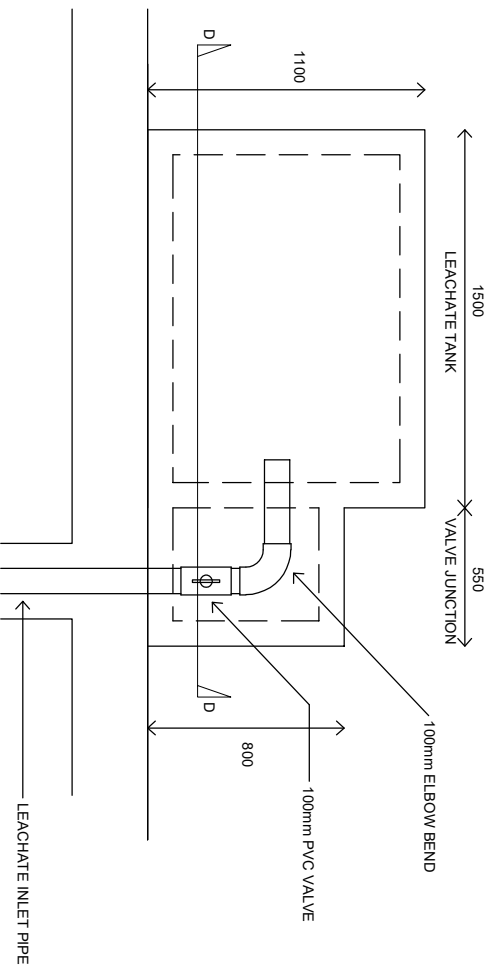

LEACHATE TANK DETAIL
1:30

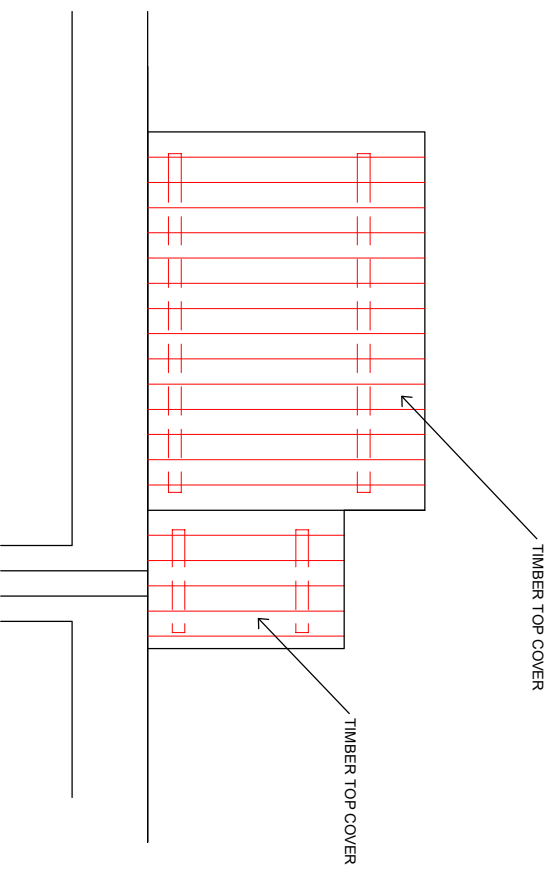

LEACHATE TANK COVER
1:30

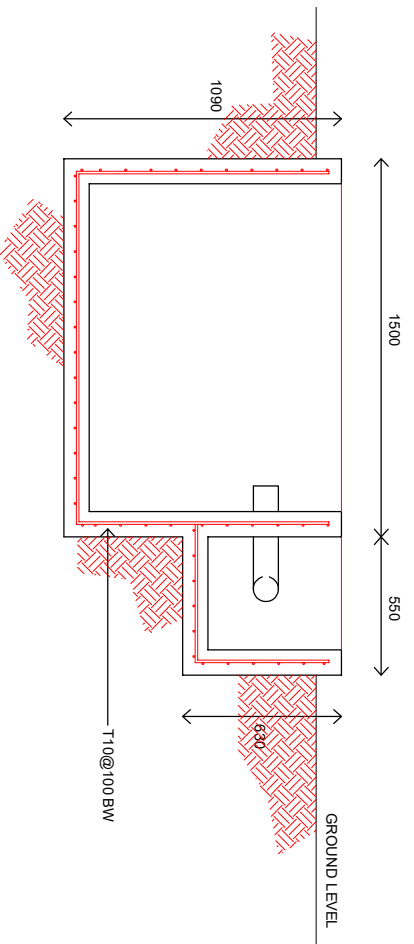

SECTION D
1:30

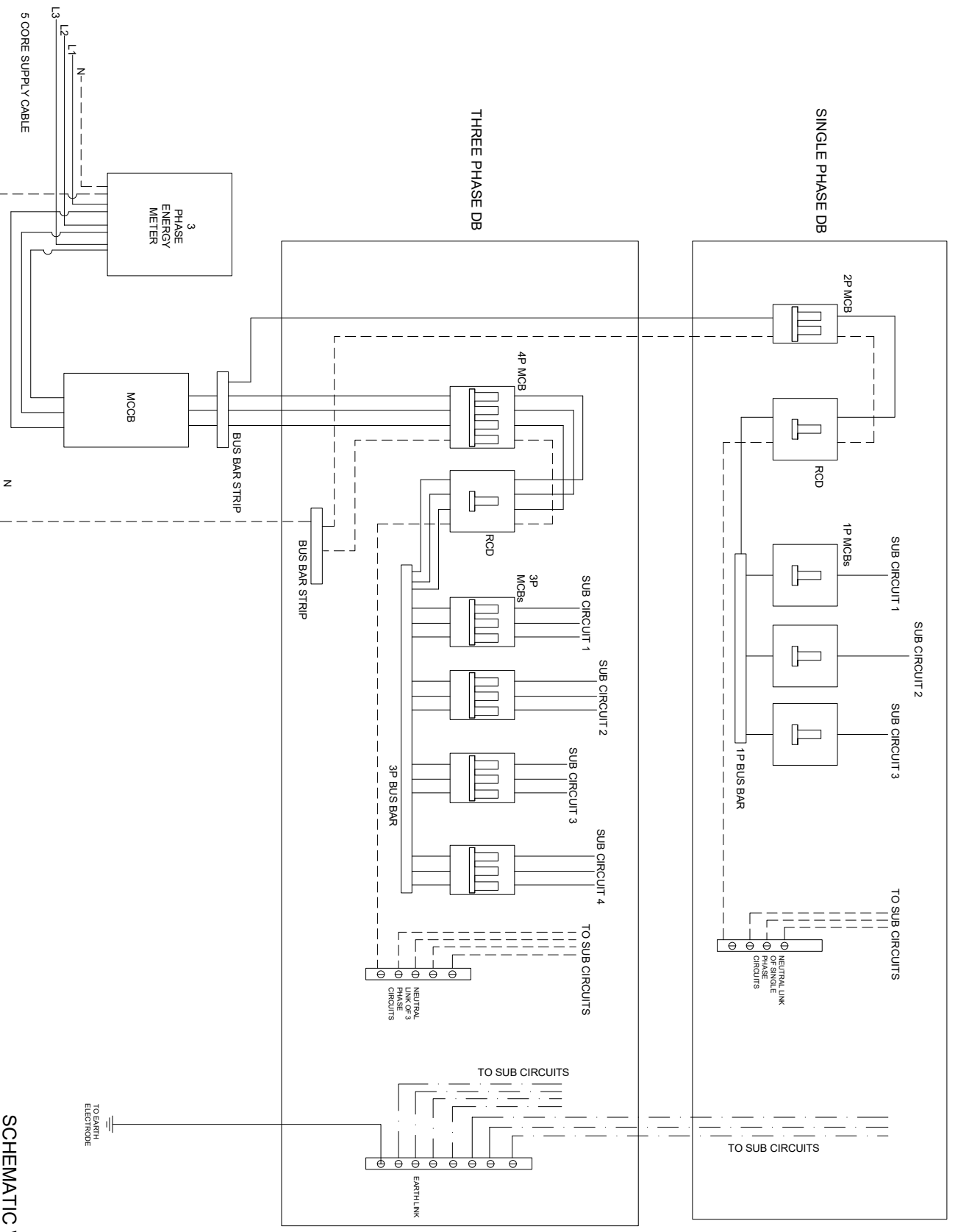

SCHEMATIC WIRING DIAGRAM

SECTION A
1:50

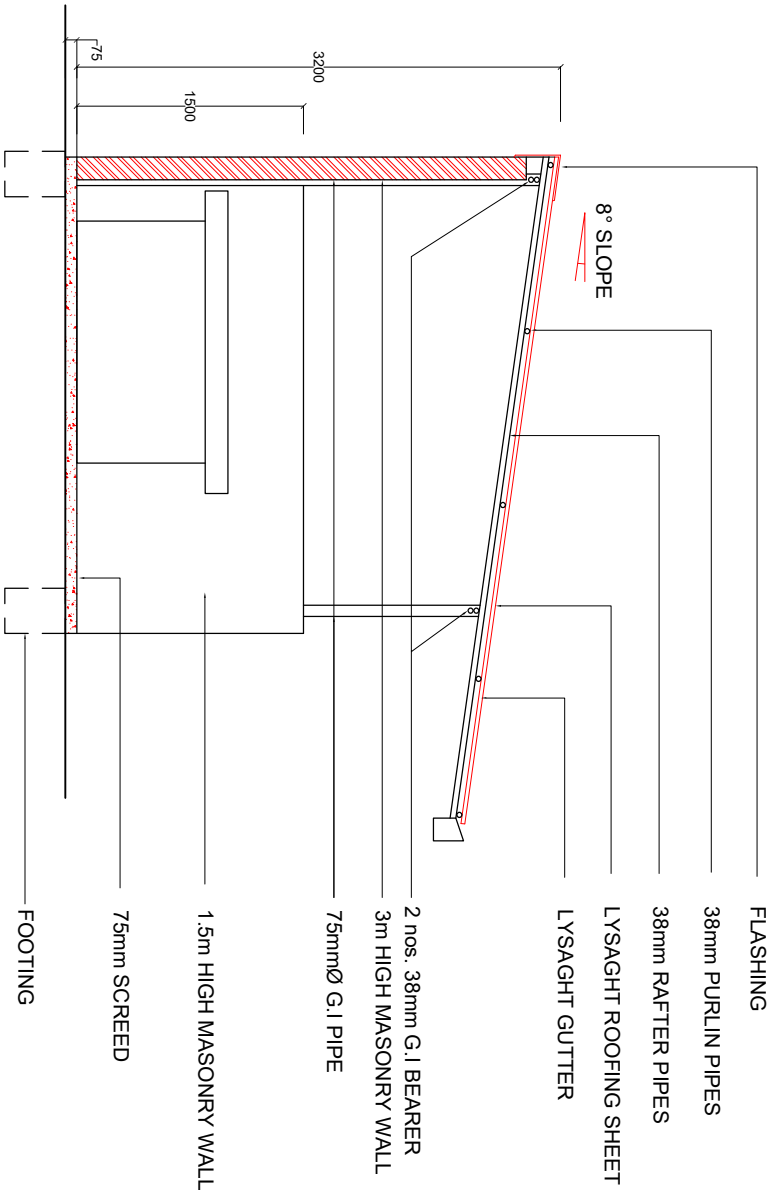

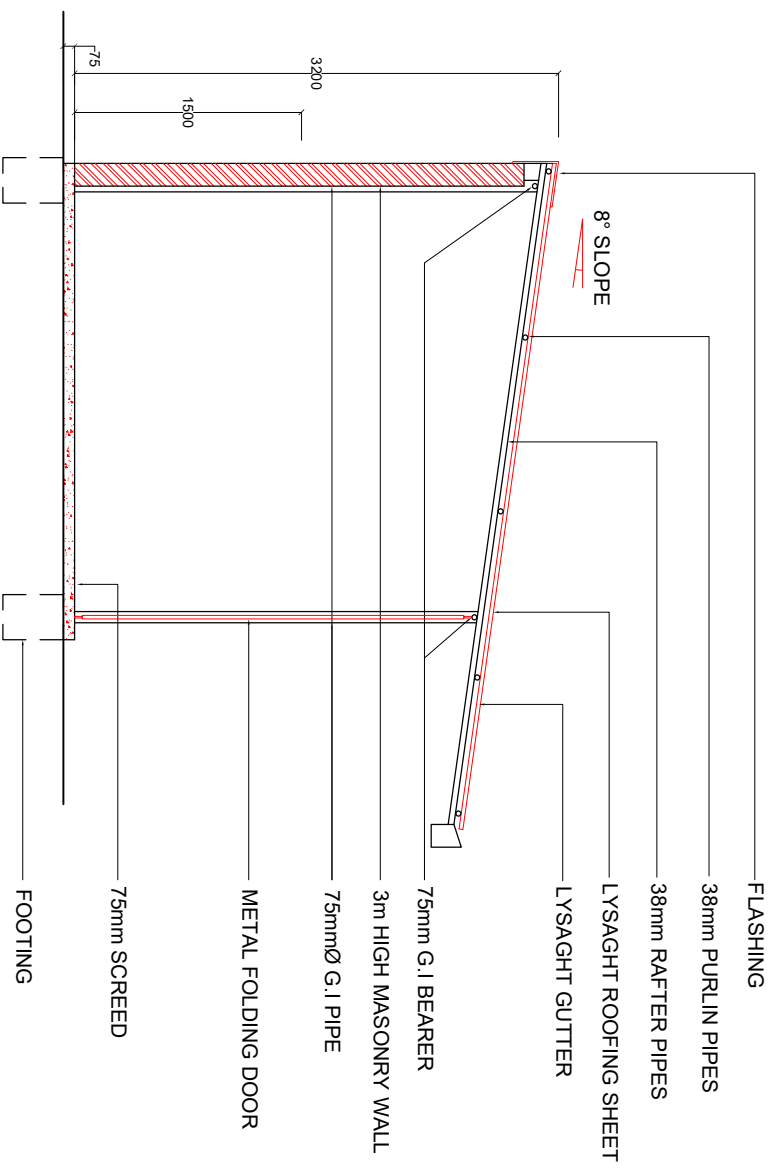

SECTION C
1:50

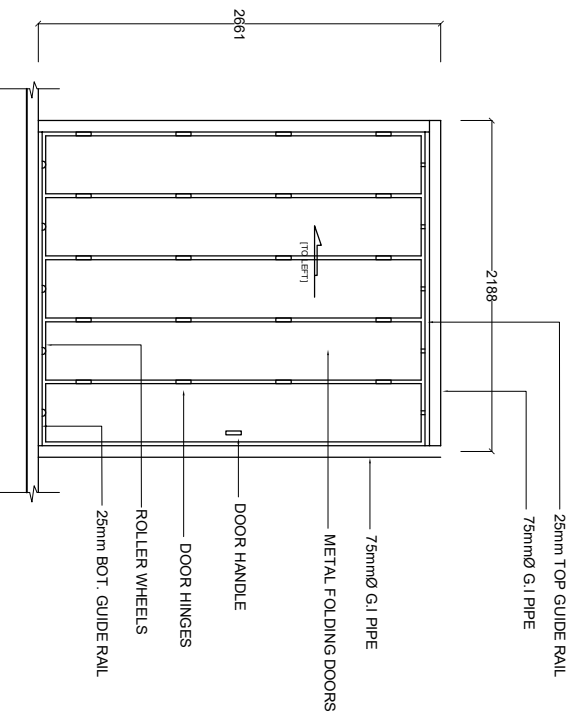

HAZARDOUS WASTE AREA
FOLDING DOOR DETAIL

1:50

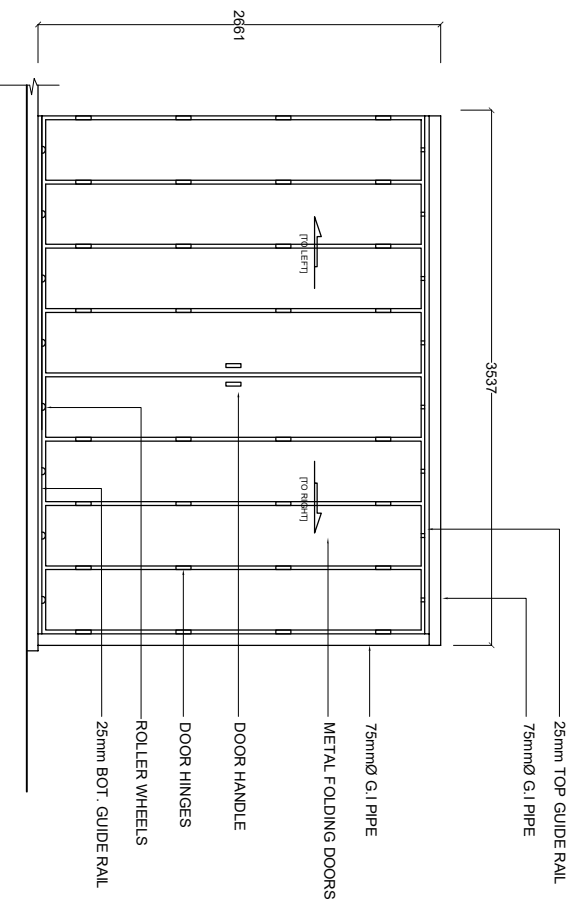

EQUIPMENT ROOM
FOLDING DOOR DETAIL

1:50

ENTRANCE / EXIT GATE
1:50

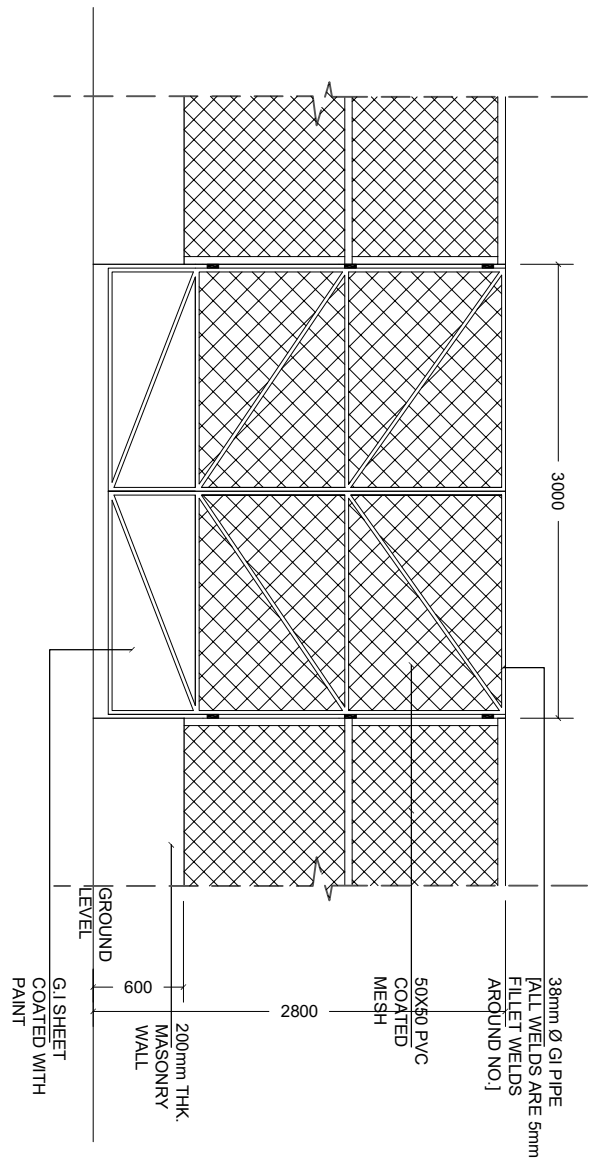

PERIMETER FENCE
1:50

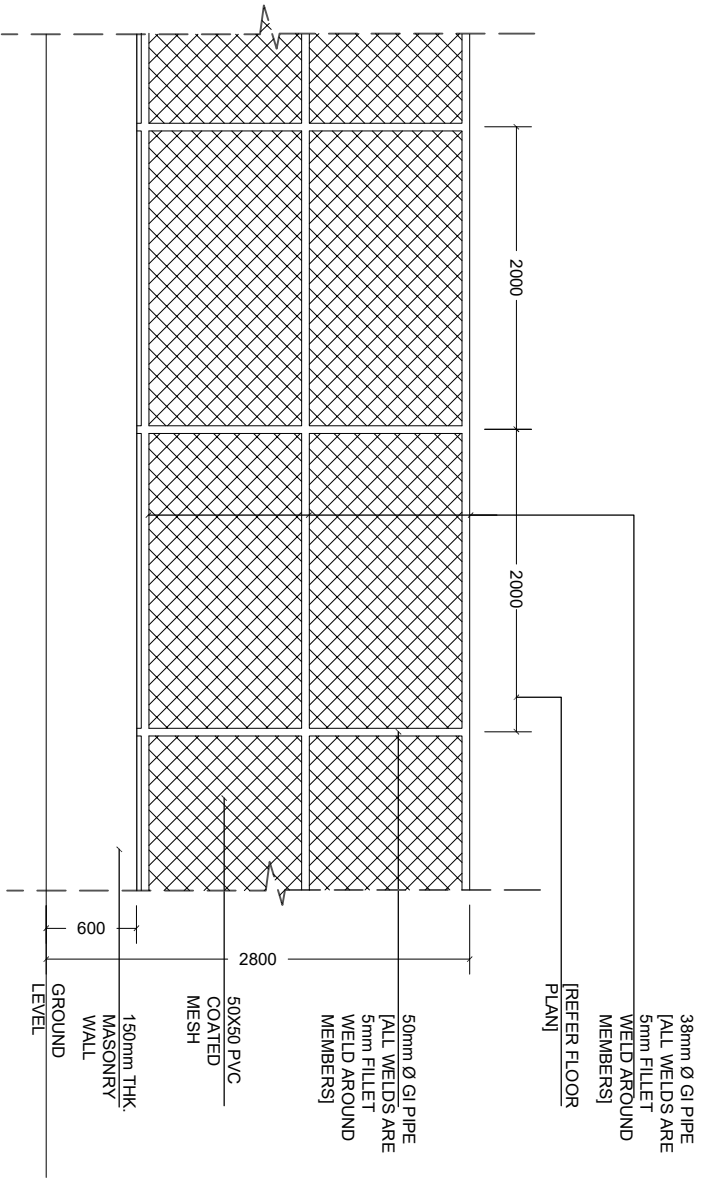

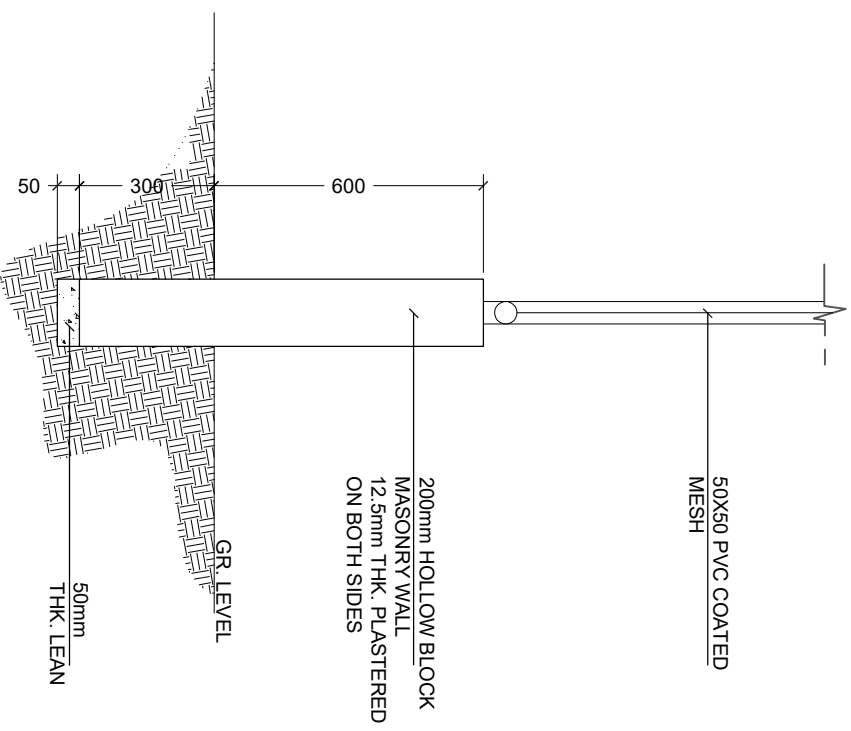
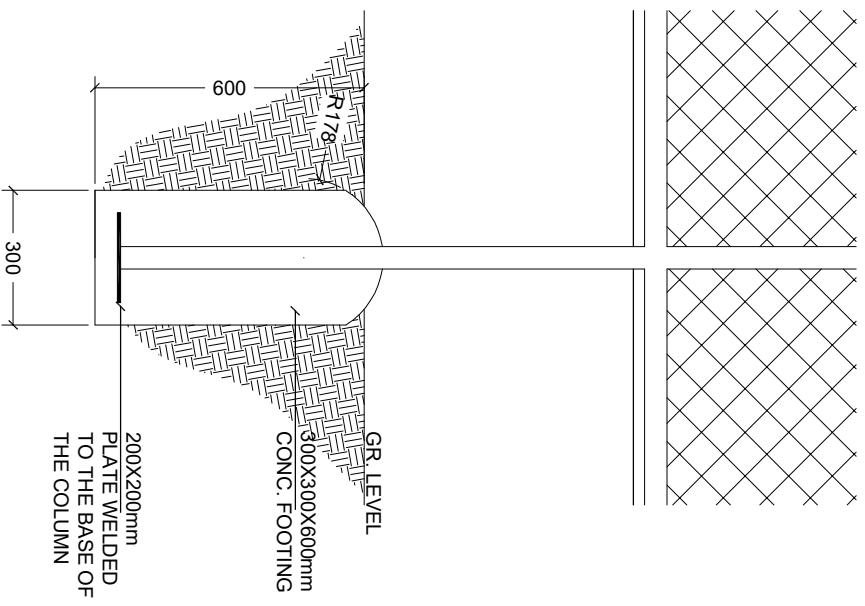

FENCE FOUNDATION DETAIL

PERIMETER WALL FOUNDATION DETAIL

PROVISION OF WATER SUPPLY SANITATION AND SOLID WASTE MANAGEMENT PROJECT
 OPEC FUND FOR INTERNATIONAL DEVELOPMENT

PROJECT: HDH NOLHIVARANFARU ISLAND WASTE MANAGEMENT CENTER

SCALE: AS SHOWN
 DATE: JUNE 2017



STATE WATER MANAGEMENT COMMITTEE
 MINISTRY OF ENVIRONMENT AND ENERGY
 KINGDOM OF BAHRAIN
 1992/5/1992/5

WASTE SORTING AREA
COLUMN FOUNDATION DETAIL

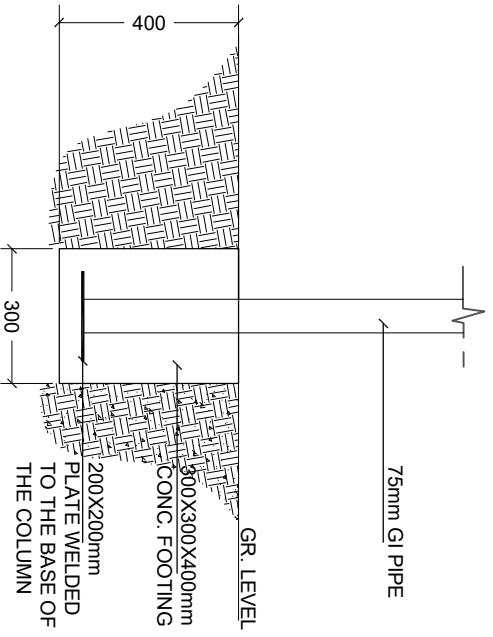

LIGHT POST FOUNDATION

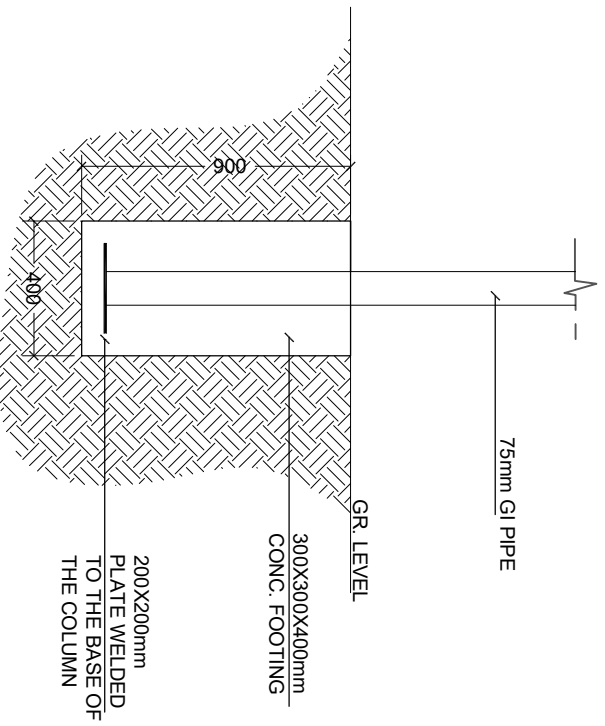

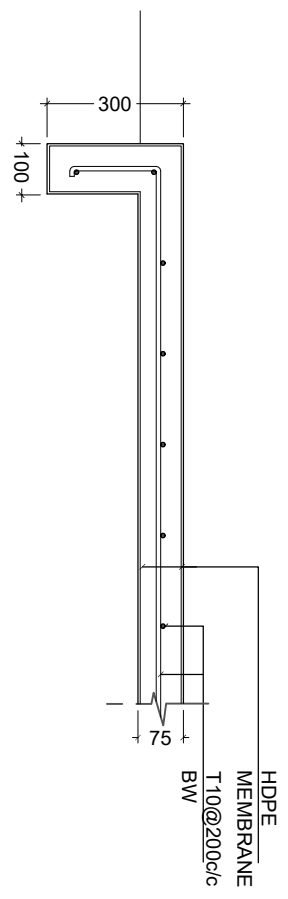
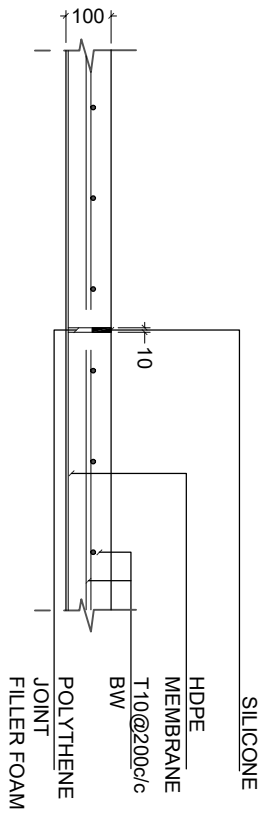
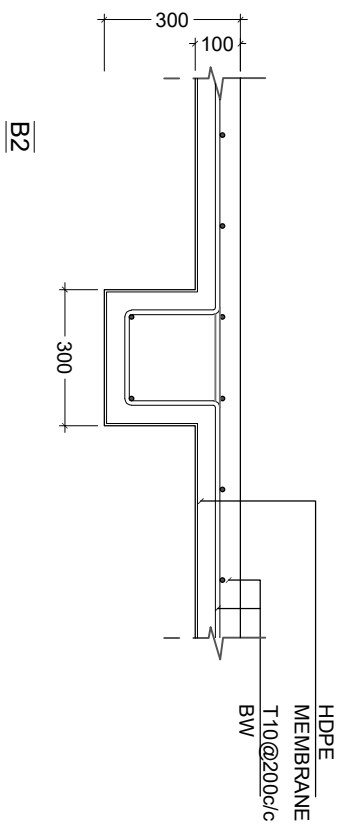
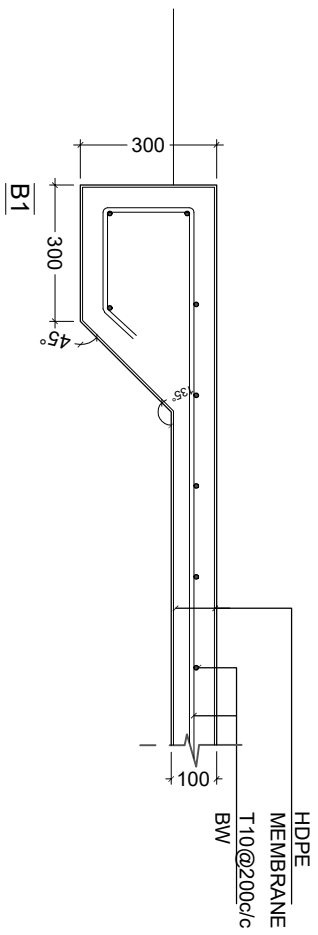

PROVISION OF WATER SUPPLY SANITATION AND SOLID
WASTE MANAGEMENT PROJECT
OPEC FUND FOR INTERNATIONAL DEVELOPMENT

PROJECT:
H.D.H NOLHIVARANFARU ISLAND WASTE MANAGEMENT
CENTER

SCALE: AS SHOWN
DATE: JUNE 2017



100MM PVC PIPE CUT IN
 HALF WITH 1% SLOPE TO
 LEACHATE WELL

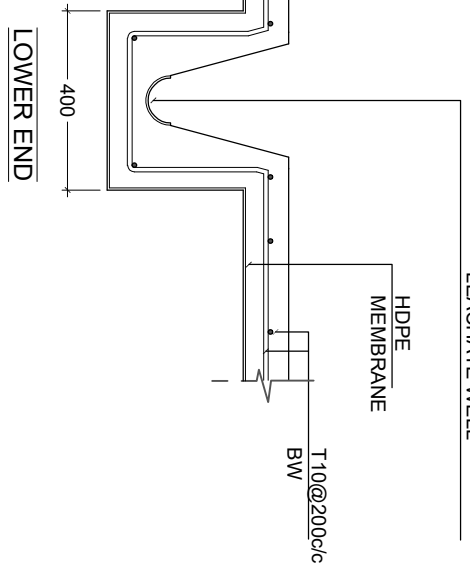
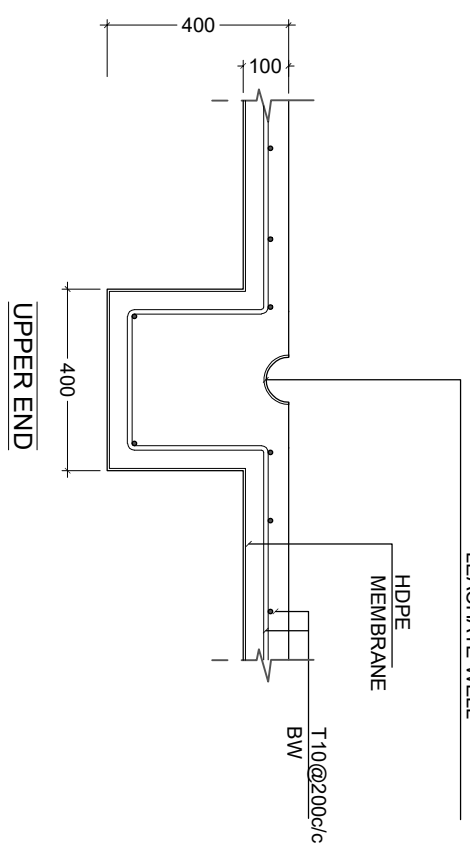

UPPER END

B3

LOWER END

HDPE
 MEMBRANE
 R6@150c/c
 BW

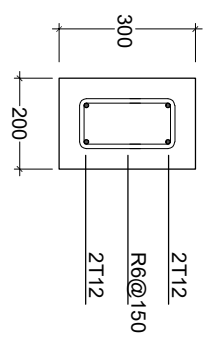
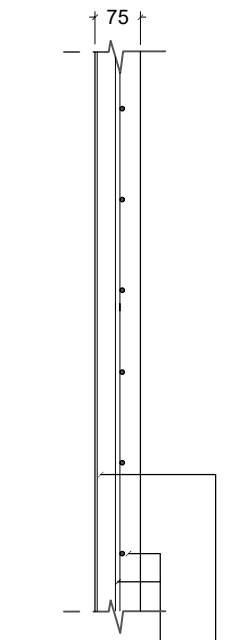

PROVISION OF WATER SUPPLY SANITATION AND SOLID
 WASTE MANAGEMENT PROJECT
 OPEC FUND FOR INTERNATIONAL DEVELOPMENT

PROJECT:
 H.D.H NOLHIVARANFARU ISLAND WASTE MANAGEMENT
 CENTER

SCALE: AS SHOWN
 DATE: JUNE 2017



STATE WATER MANAGEMENT COMMITTEE
 600 PROJECT
 MINISTRY OF ENVIRONMENT AND ENERGY
 REPUBLIC OF MALDIVES, MALÉ 2017

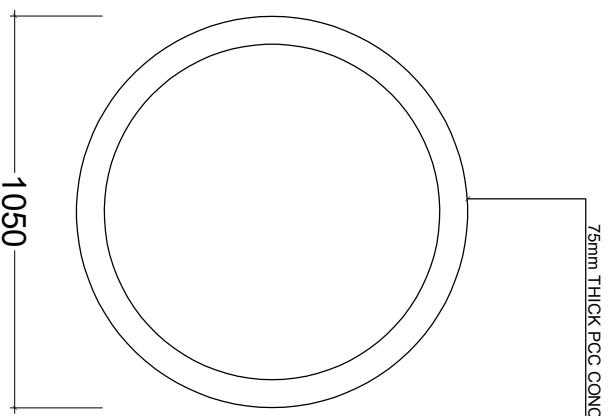

GROUND WATER WELL

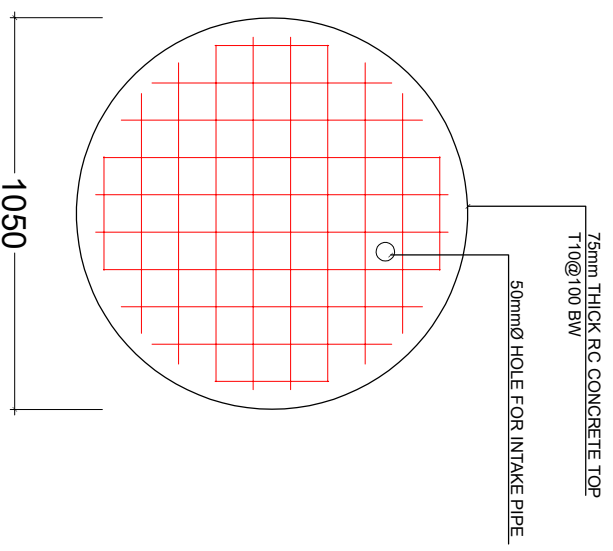

GROUND WATER WELL - TOP

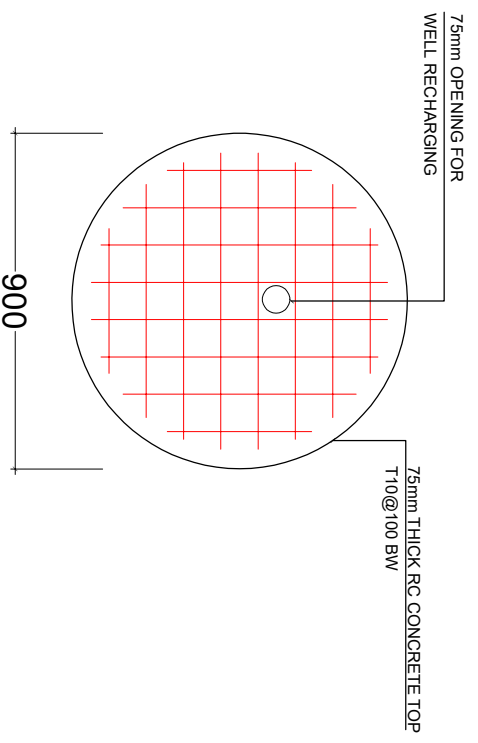

GROUND WATER WELL - BASE

PROVISION OF WATER SUPPLY SANITATION AND SOLID WASTE MANAGEMENT PROJECT
 OPEC FUND FOR INTERNATIONAL DEVELOPMENT

PROJECT:
 HDDH NOLHIVARANFARU ISLAND WASTE MANAGEMENT CENTER

SCALE: AS SHOWN
 DATE: JUNE 2017



STATE WATER MANAGEMENT COMMITTEE
 600 PROJECT
 MINISTRY OF ENVIRONMENT AND ENERGY
 NINGLOMANGI BUILDING, NMC 70-01
 100000 S. BALI

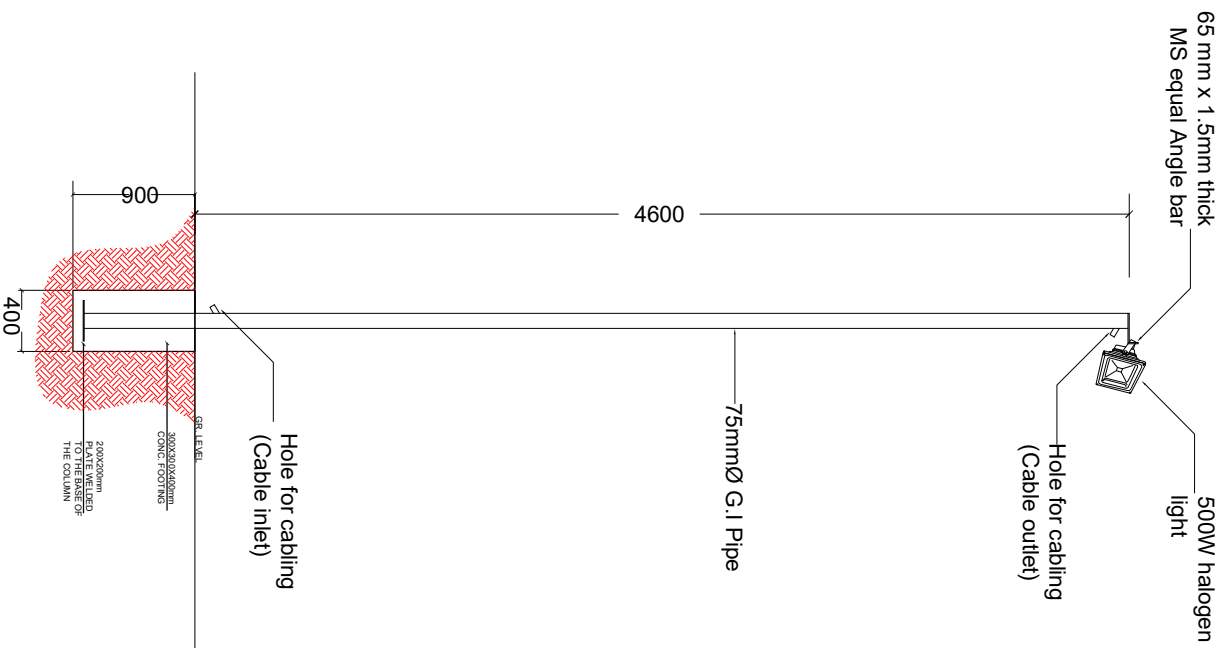

* GI pipe to be painted with 1 coat of sealer
& 2 coats of finishing paint. (Sigma, Grey colour)

LIGHT POST DETAIL

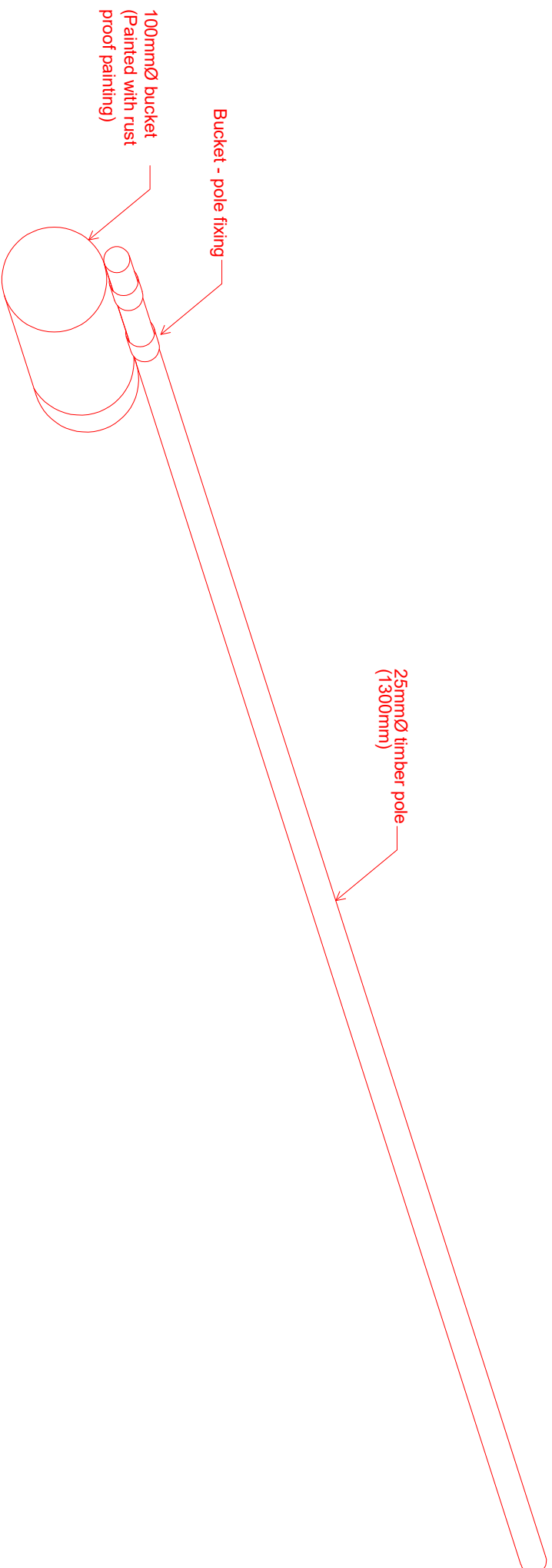

"DHAANI" FOR LEACHATE TANK

PROVISION OF WATER SUPPLY SANITATION AND SOLID
WASTE MANAGEMENT PROJECT
OPEC FUND FOR INTERNATIONAL DEVELOPMENT

PROJECT:
H.DH NOLHIVARANFARU ISLAND WASTE MANAGEMENT
CENTER

SCALE: AS SHOWN
DATE: JUNE 2017

 <p>STATE WATER MANAGEMENT COMMITTEE OPEC PROJECT MINISTRY OF ENVIRONMENT AND ENERGY MALDIVES 195205 5</p>
--