

PROVISION OF WATER SUPPLY SANITATION AND SOLID WASTE MANAGEMENT PROJECT

H.A. KELAA ISLAND WASTE MANAGEMENT CENTER

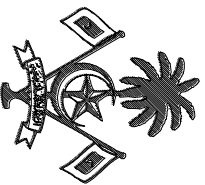

SOLID WASTE MANAGEMENT COMPONENT
OF ID PROJECT
MINISTRY OF ENVIRONMENT AND ENERGY

HANDHUVAAREE HINGUN MALE' 20-01
REPUBLIC OF MALDIVES

ACCESS ROAD

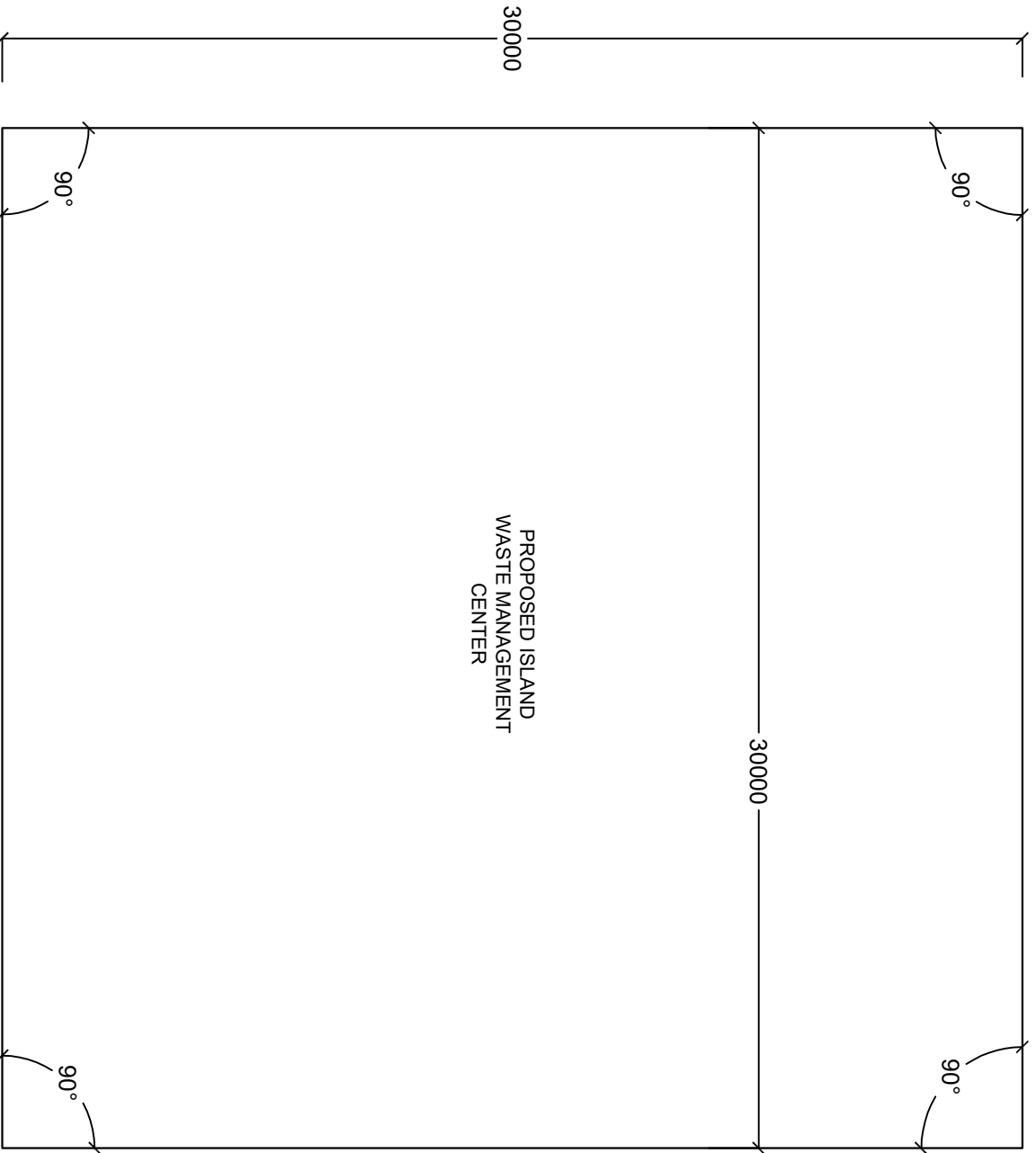

PROPOSED ISLAND
WASTE MANAGEMENT
CENTER

30000

30000

90°

90°

90°

90°

SITE PLAN

1:200

PROVISION OF WATER SUPPLY SANITATION AND SOLID
WASTE MANAGEMENT PROJECT
OPEC FUND FOR INTERNATIONAL DEVELOPMENT

PROJECT:
H.A. KELAA ISLAND WASTE MANAGEMENT CENTER

SCALE: AS SHOWN

DATE: OCT 2017



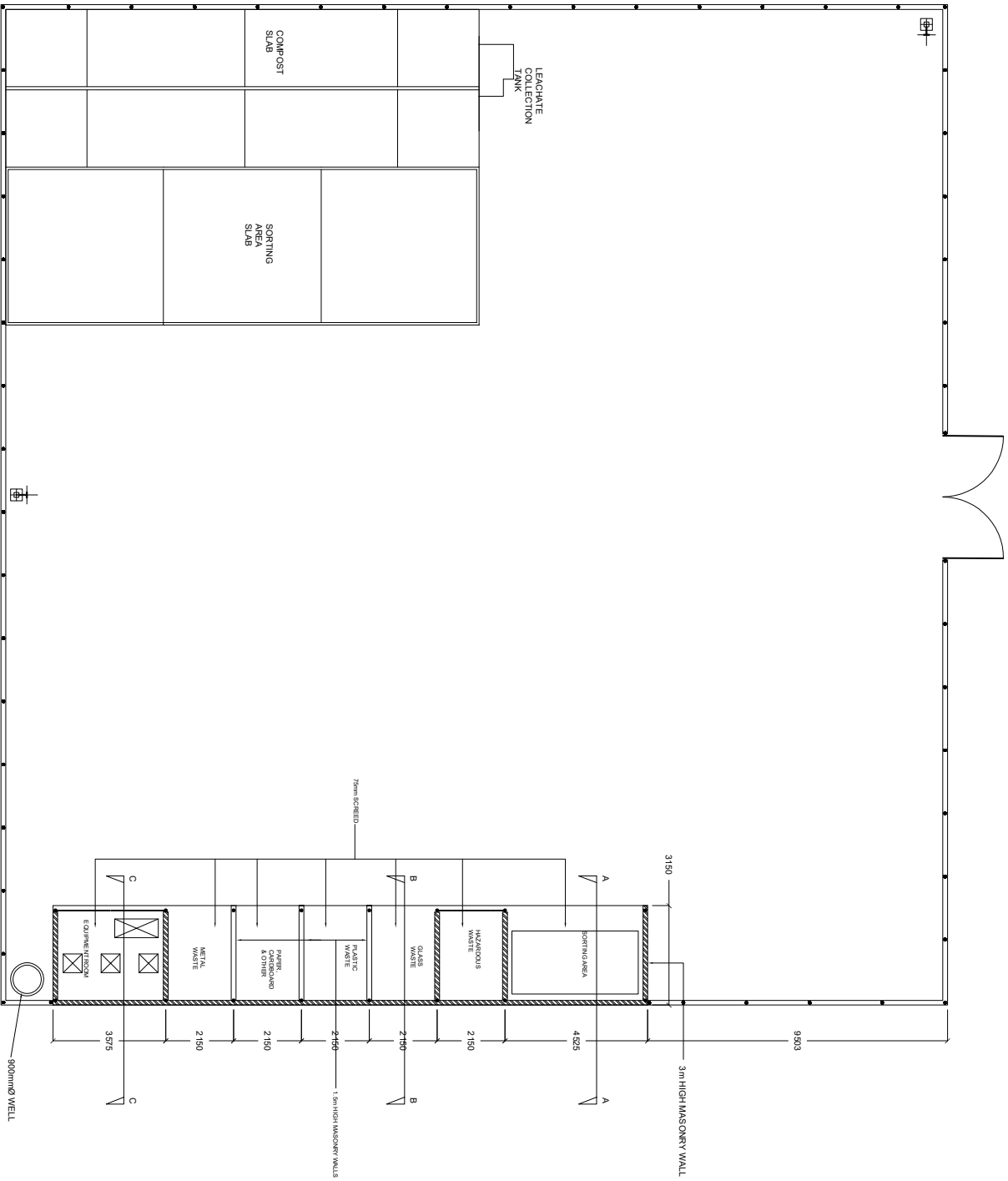

IWMC LAYOUT
 1:200

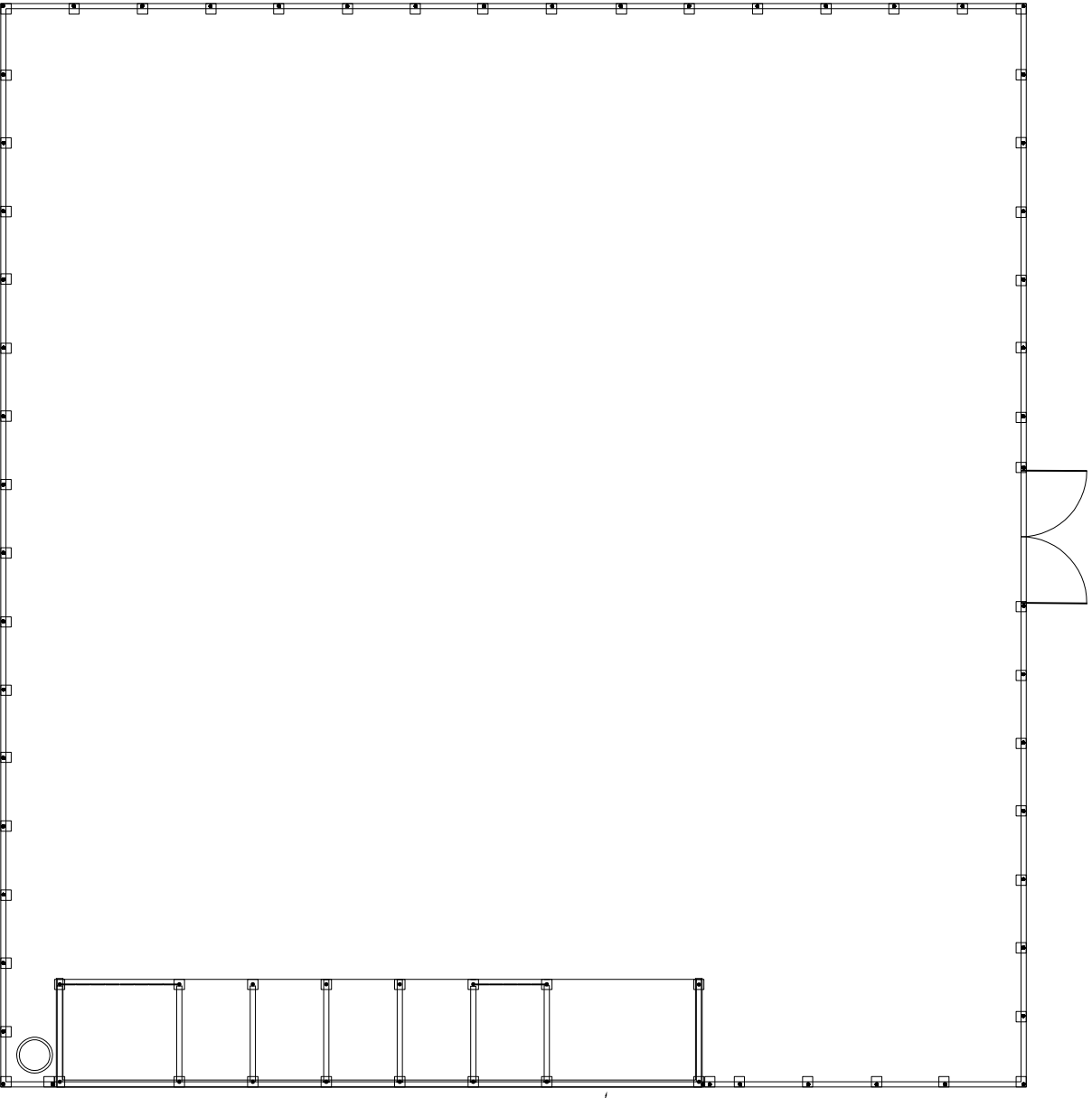

LINE FOOTING
FOR 5m HIGH
WALL

FENCE FOUNDATION AND COLLECTION
AREA FOUNDATION

1:200

PROVISION OF WATER SUPPLY SANITATION AND SOLID
WASTE MANAGEMENT PROJECT
OPEC FUND FOR INTERNATIONAL DEVELOPMENT

PROJECT:
H.A. KELAA ISLAND WASTE MANAGEMENT CENTER

SCALE: AS SHOWN
DATE: OCT 2017

 KINGDOM OF BAHRAIN
 MINISTRY OF ENVIRONMENT AND ENERGY
 WASTE MANAGEMENT CENTER
 H.A. KELAA ISLAND

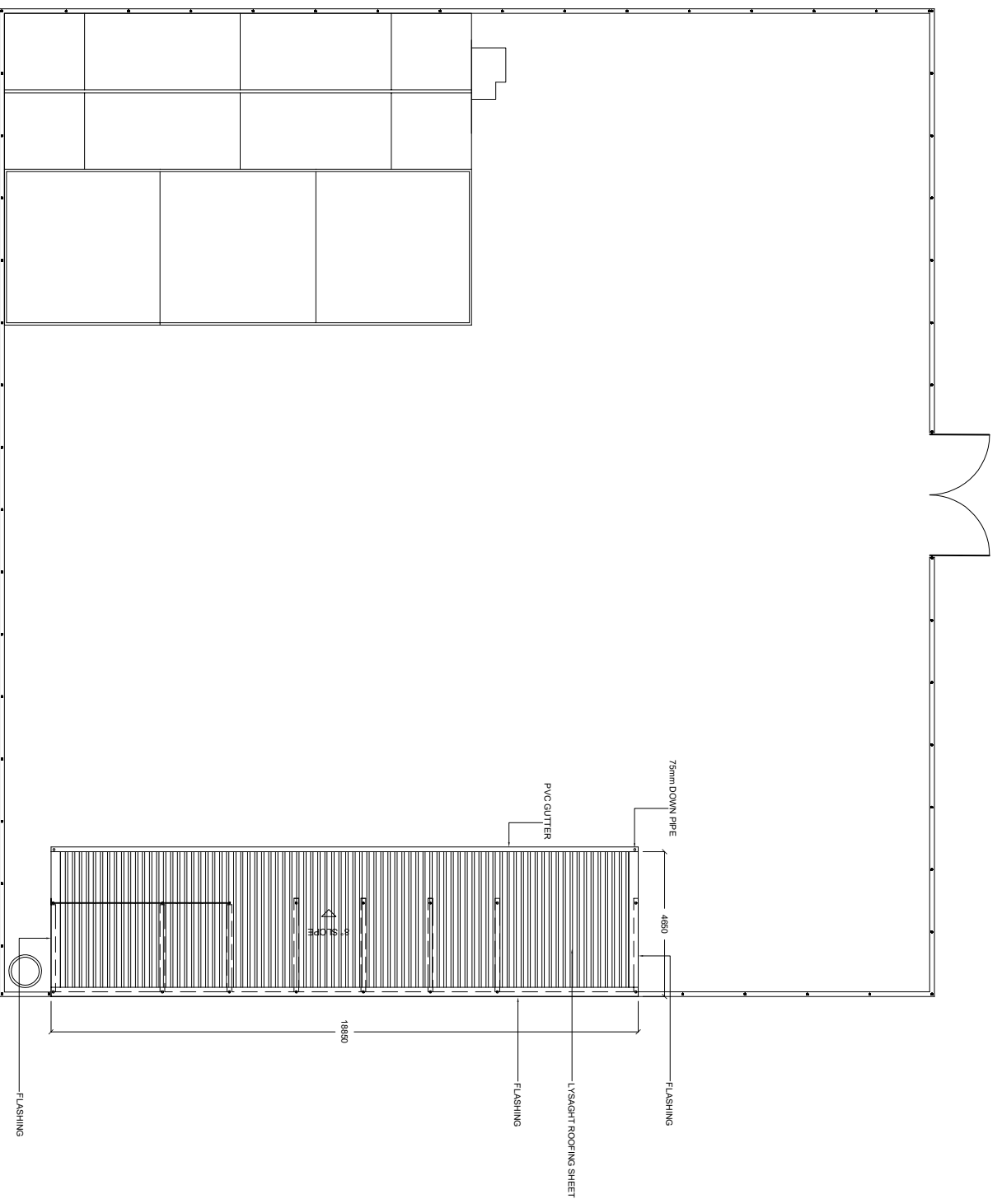

1:200
ROOF PLAN

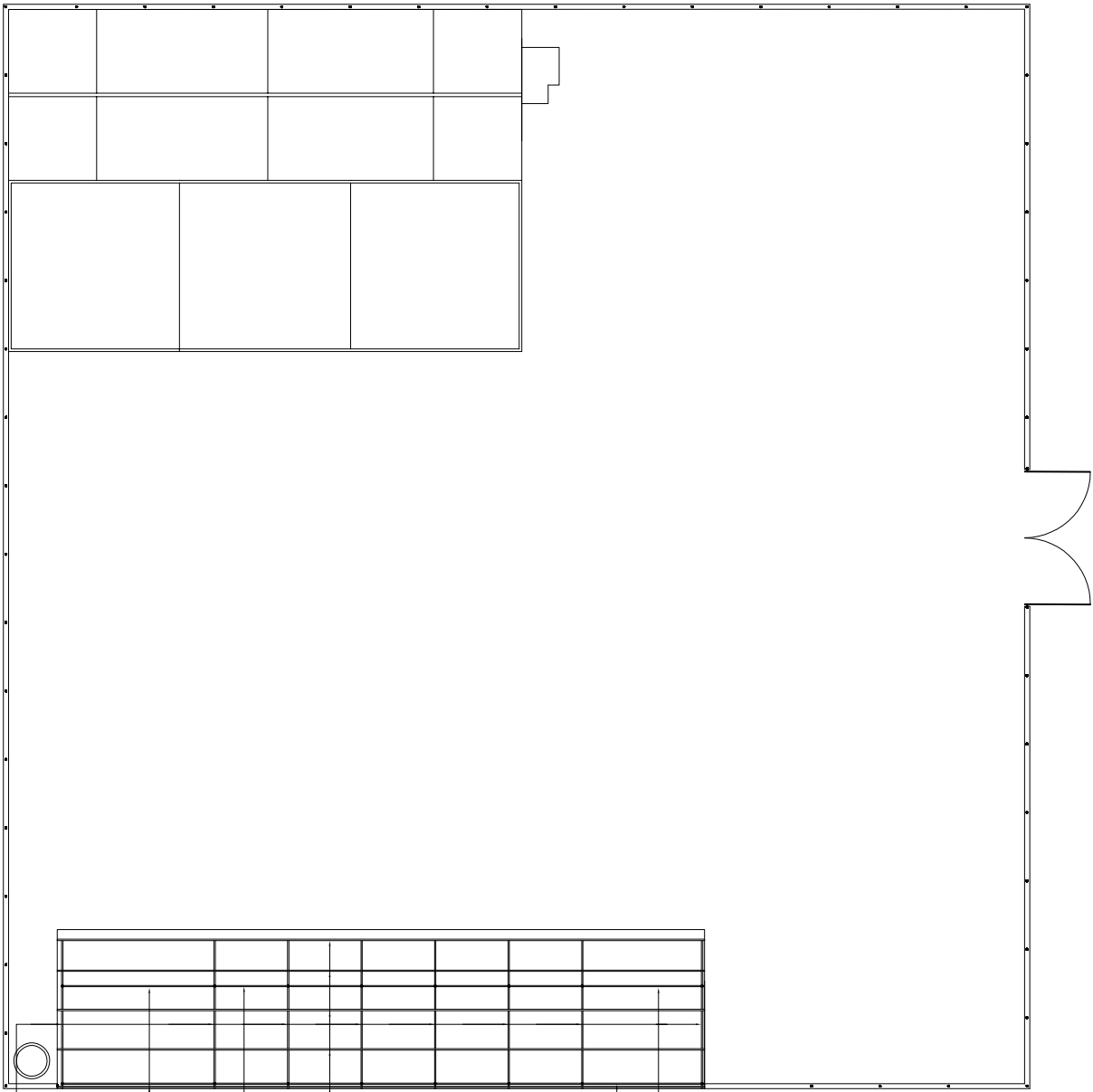

- 75mm Ø G.I. Pipe
- 2 nos. 38mm Ø G.I. Pipe
- 38mm Ø G.I. Pipe purfling
- 75mm Ø G.I. Pipe
- 2 nos. 38mm Ø G.I. Section Pipe
- 38mm Ø G.I. Pipe

1:200

ROOF FRAMING PLAN

PROVISION OF WATER SUPPLY SANITATION AND SOLID WASTE MANAGEMENT PROJECT
 OPEC FUND FOR INTERNATIONAL DEVELOPMENT

PROJECT:
 H.A. KELAA ISLAND WASTE MANAGEMENT CENTER

SCALE: AS SHOWN
DATE: OCT 2017



STATE WATER MANAGEMENT COMMISSION
 MINISTRY OF ENVIRONMENT AND ENERGY
 KINGDOM OF BAHRAIN

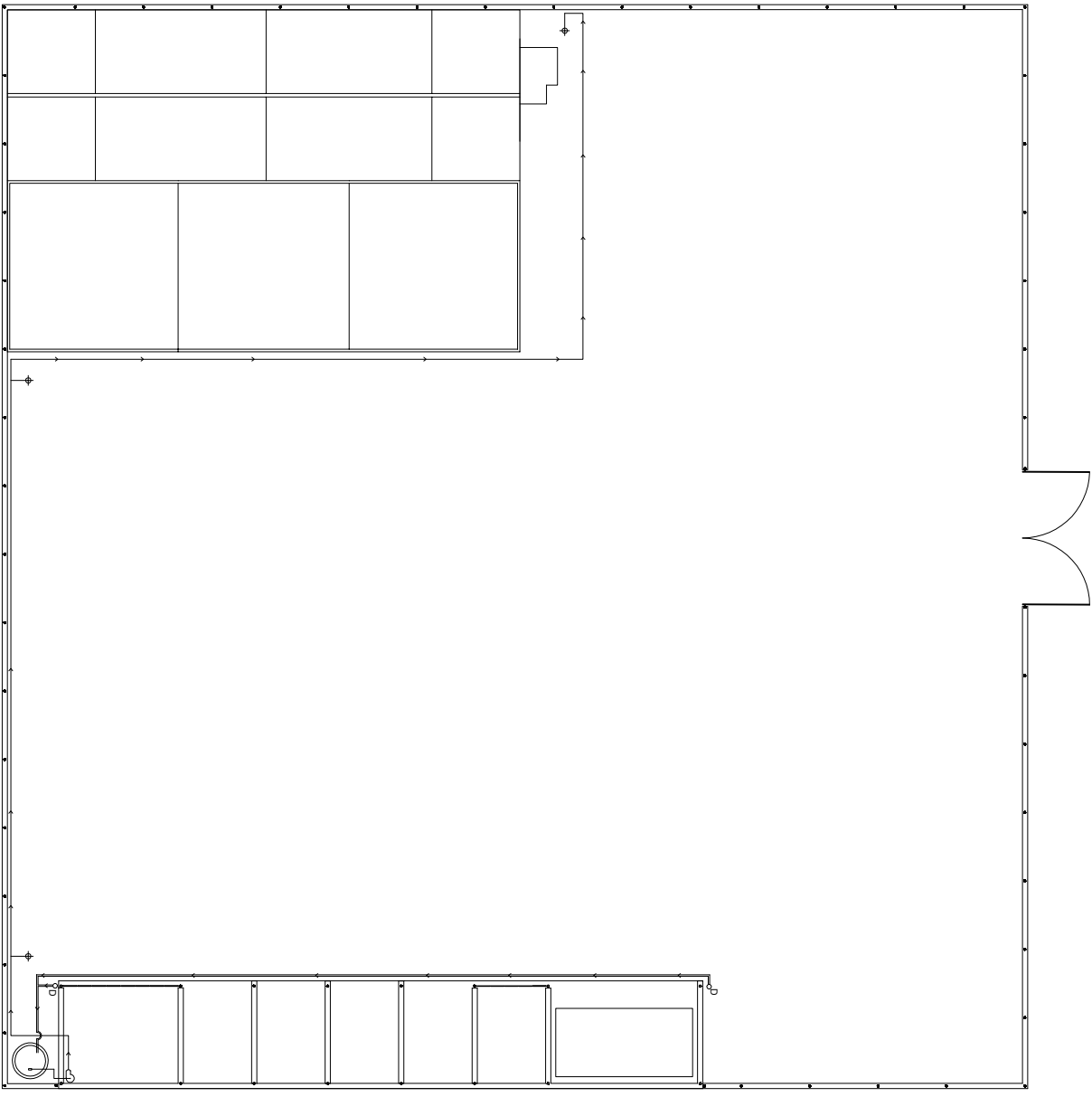

- 75mm Conveyance pipe
- o D Down pipe
- Fock valve
- Shallow well pump (230 V, 500 W)
- Metal lap

1:200
 PLUMBING LAYOUT

PROVISION OF WATER SUPPLY SANITATION AND SOLID
 WASTE MANAGEMENT PROJECT
 OPEC FUND FOR INTERNATIONAL DEVELOPMENT

PROJECT:
 H.A. KELAA ISLAND WASTE MANAGEMENT CENTER

SCALE: AS SHOWN
 DATE: OCT 2017



1:200
 ELECTRICAL LAYOUT

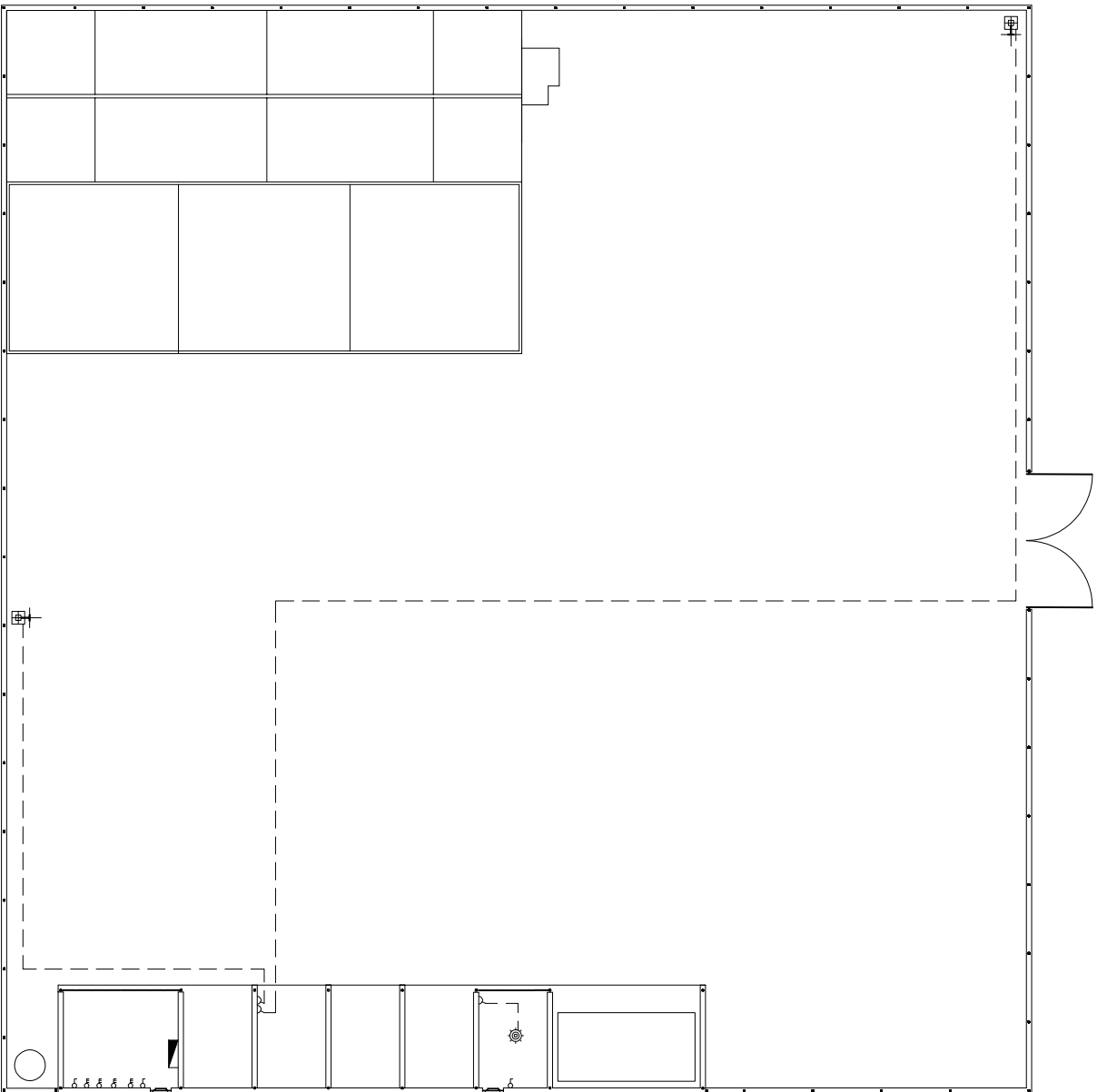

- DISTRIBUTION BOARD
- LOW ENERGY SAVING LIGHT
- 3 PHASE POWER POINTS (1m ABOVE GROUND)
- 1 PHASE POWER POINTS (1m ABOVE GROUND)
- WEATHER PROOF SWITCH
- EXHAUST FAN (1.2m DIAMETER, 230 V, 250 W)

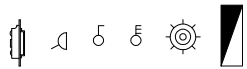

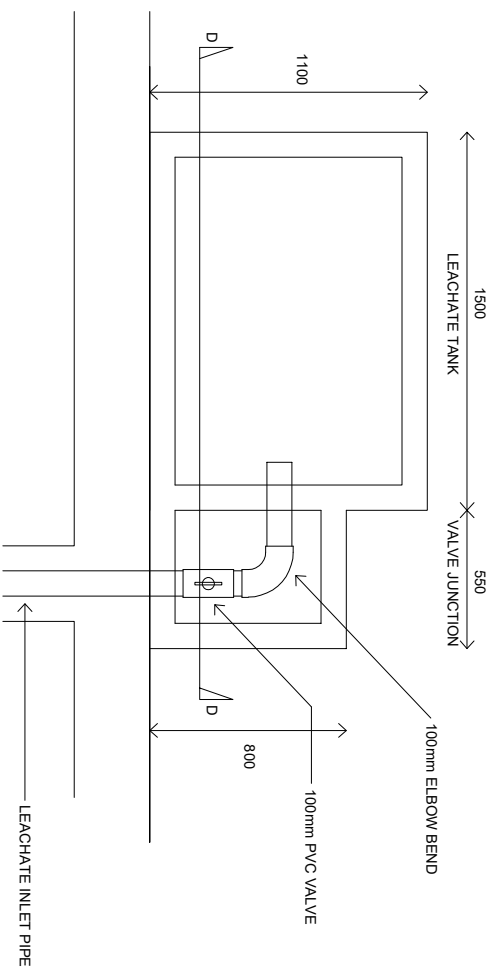

LEACHATE TANK DETAIL
1:30

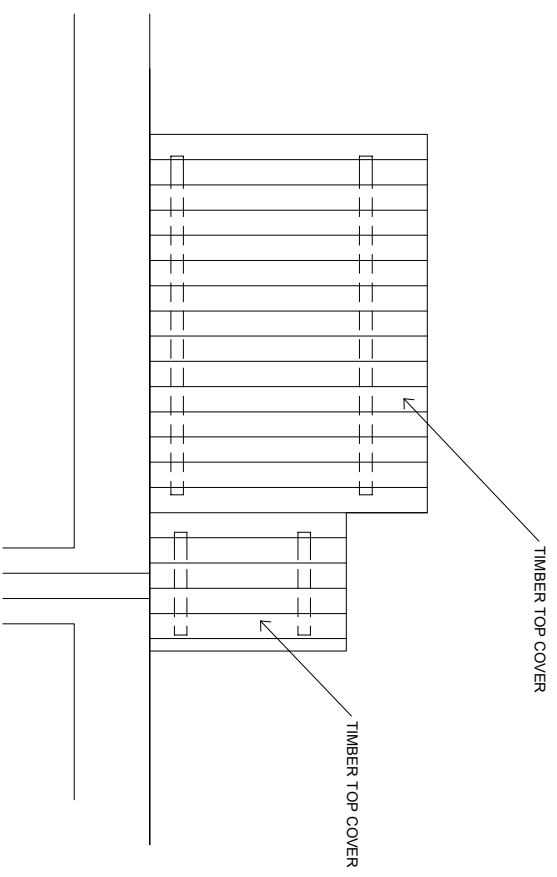

LEACHATE TANK COVER
1:30

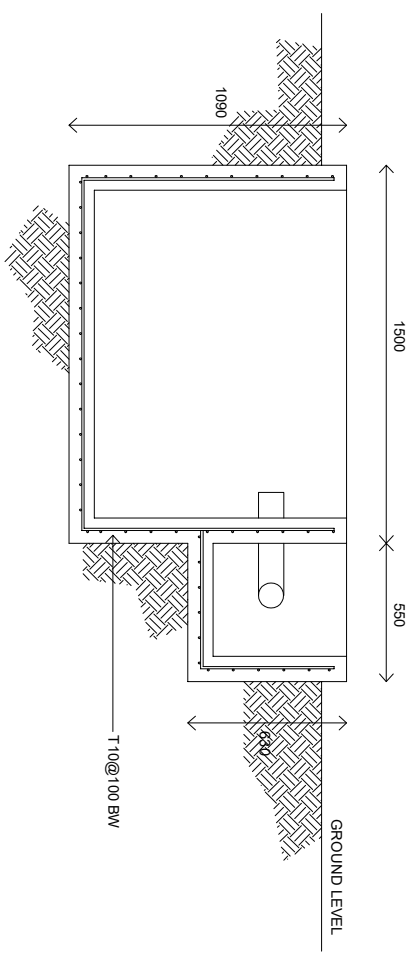

SECTION D
1:30

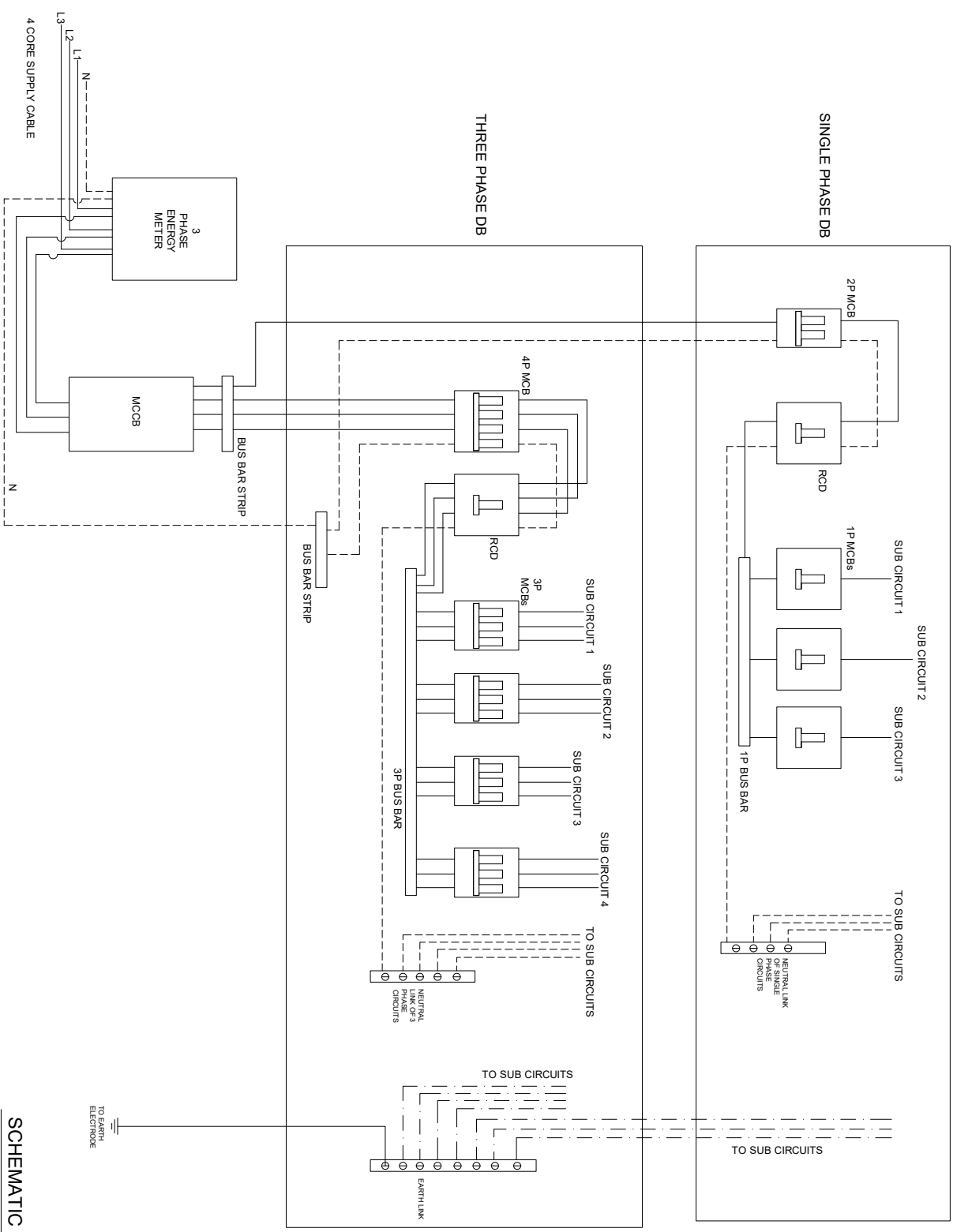

SCHEMATIC WIRING DIAGRAM

SECTION A
1:50

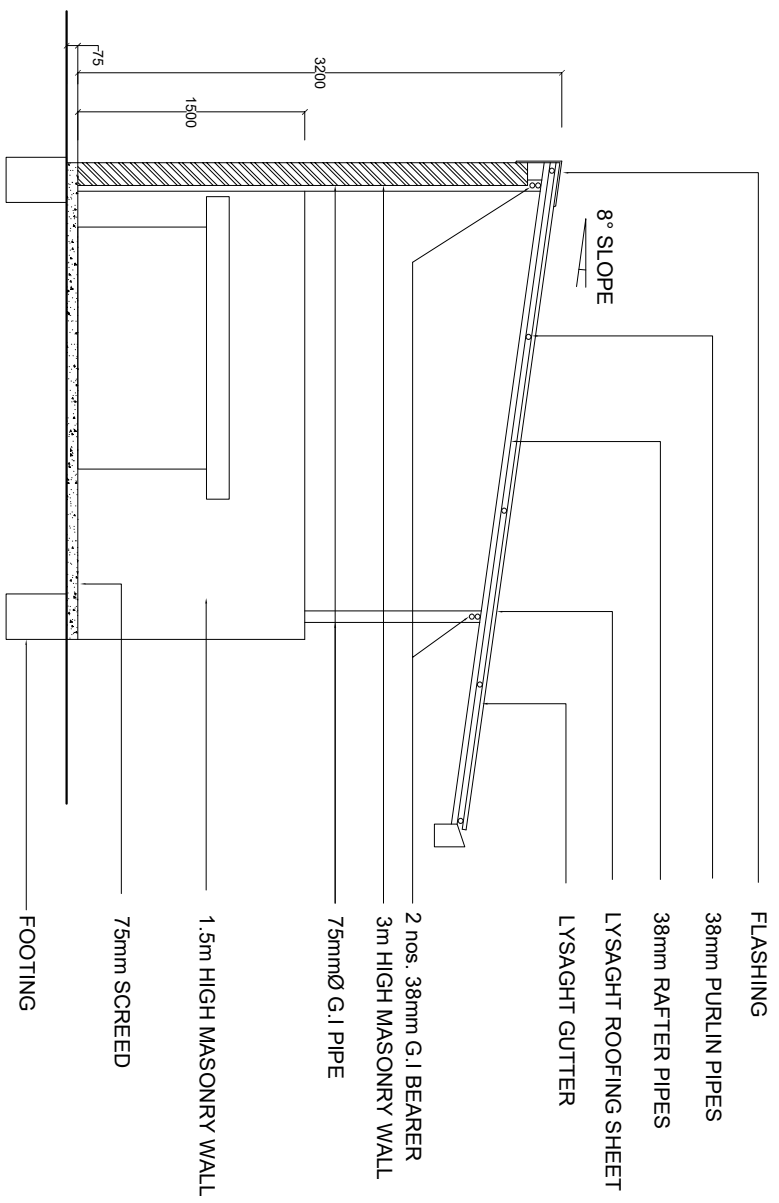

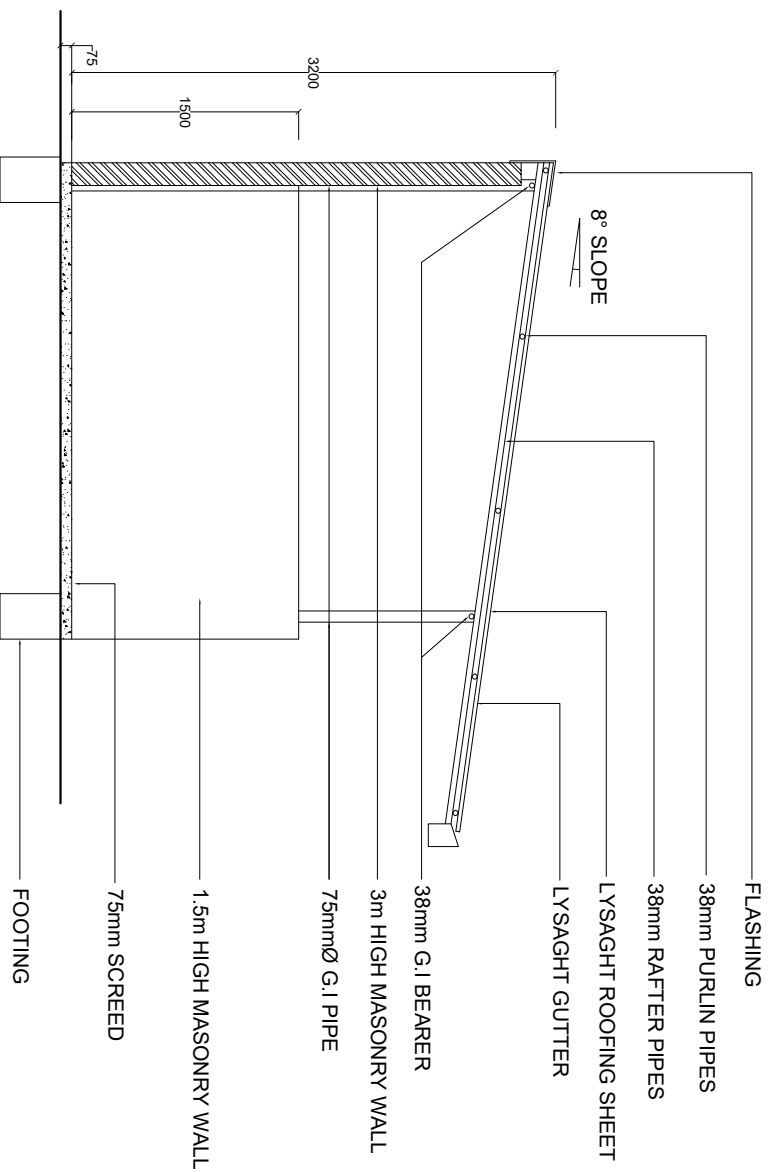

SECTION B
1:50

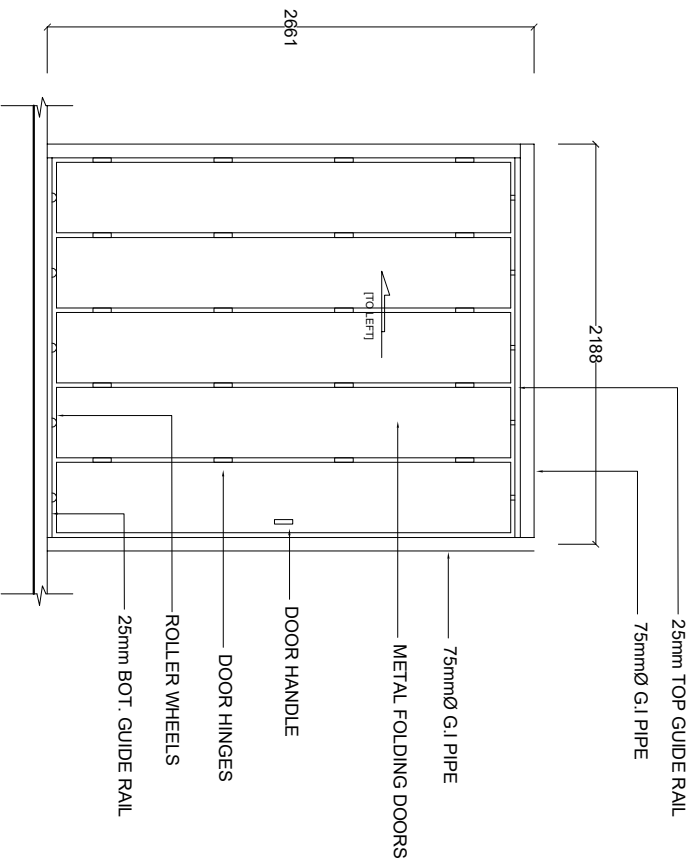

**HAZARDOUS WASTE AREA
FOLDING DOOR DETAIL**

1:50

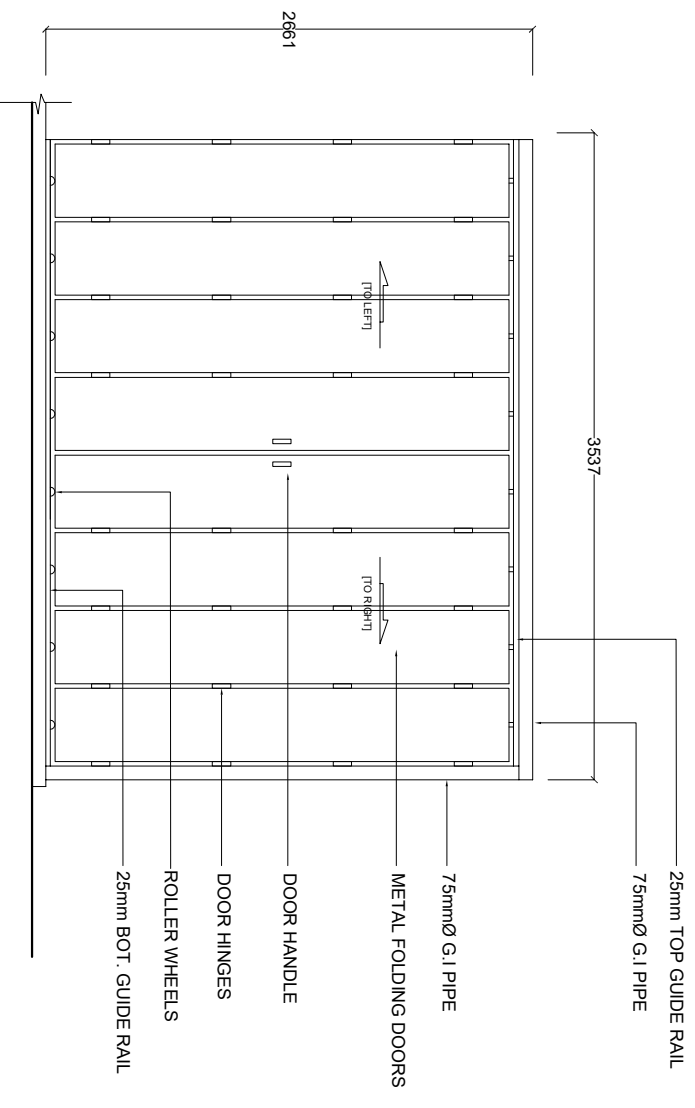

**EQUIPMENT ROOM
FOLDING DOOR DETAIL**

1:50

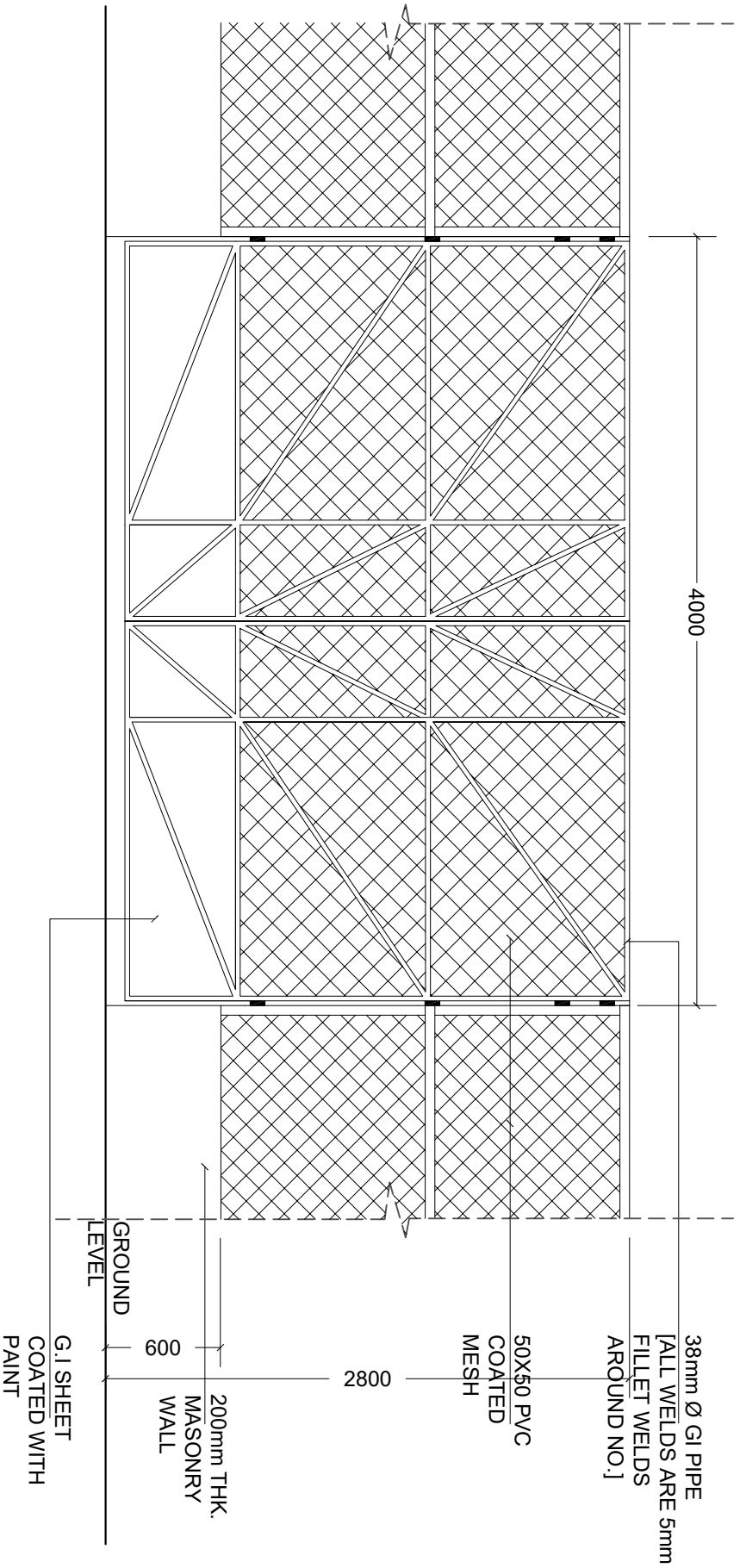

ENTRANCE / EXIT GATE
1:50

PROVISION OF WATER SUPPLY SANITATION AND SOLID
WASTE MANAGEMENT PROJECT
OPEC FUND FOR INTERNATIONAL DEVELOPMENT

PROJECT:
H.A. KELAA ISLAND WASTE MANAGEMENT CENTER

SCALE: AS SHOWN
DATE: OCT 2017

SOA WASTE MANAGEMENT COMPONENT
OF THE PROJECT
MINISTRY OF ENVIRONMENT AND ENERGY
SALVADOR
PROVIDING FINANCIAL SUPPORT
1998-2001

PERIMETER FENCE 1:50

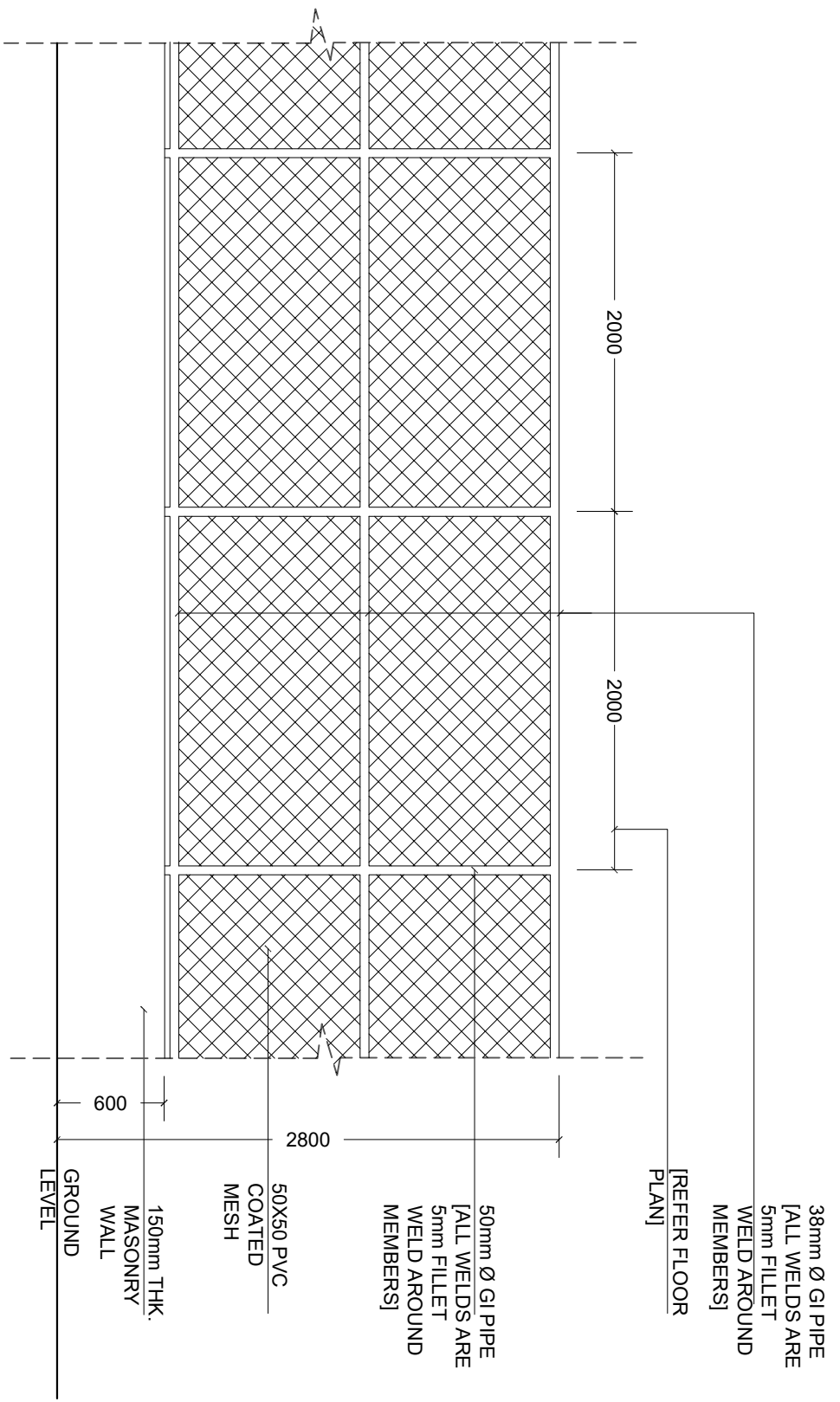

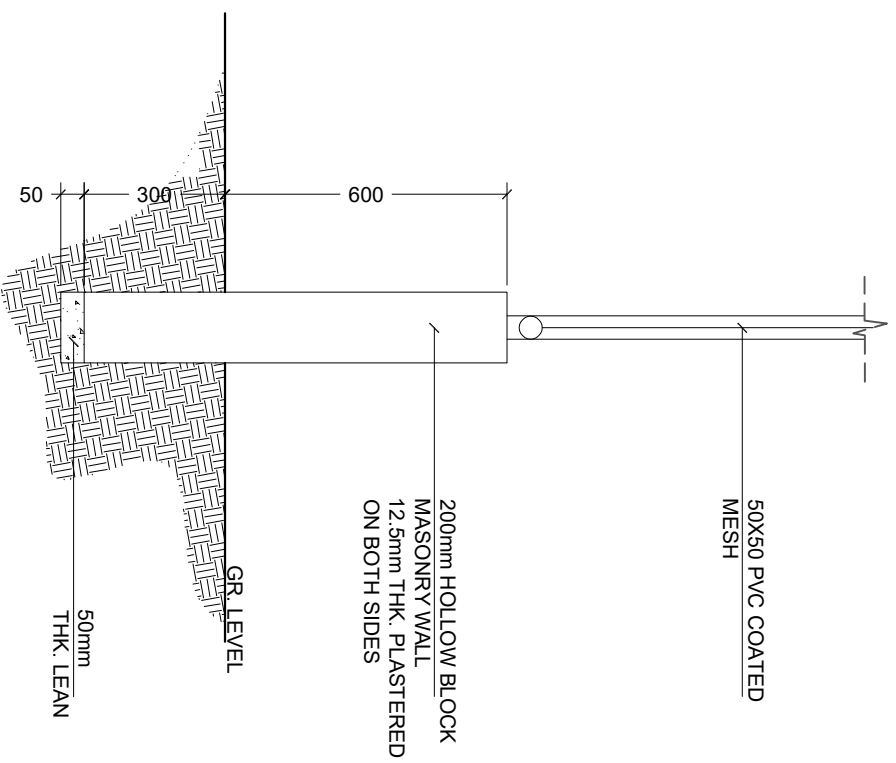
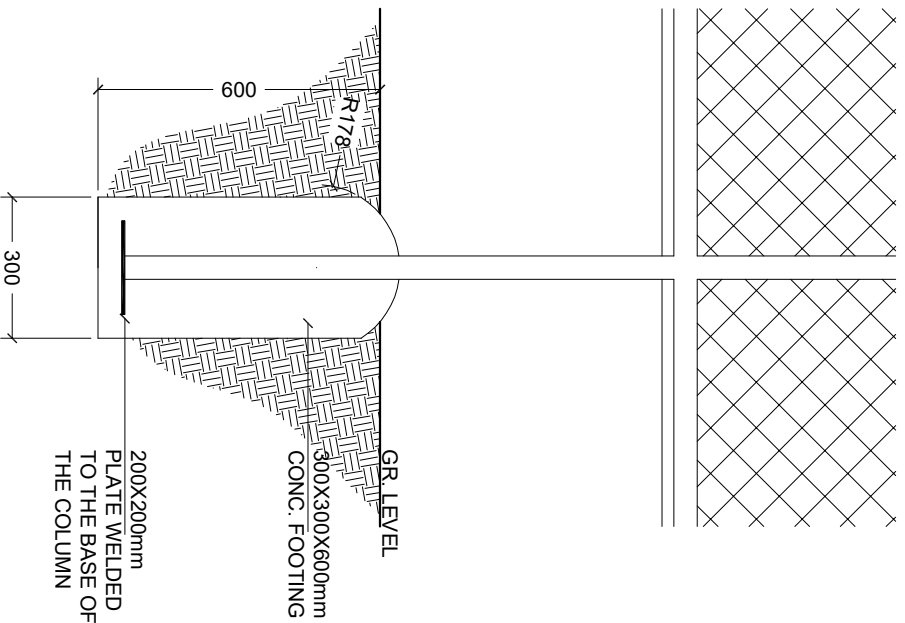

FENCE FOUNDATION DETAIL

PERIMETER WALL FOUNDATION DETAIL

PROVISION OF WATER SUPPLY SANITATION AND SOLID WASTE MANAGEMENT PROJECT
 OPEC FUND FOR INTERNATIONAL DEVELOPMENT

PROJECT:
 H.A. KELAA ISLAND WASTE MANAGEMENT CENTER

SCALE: AS SHOWN
 DATE: OCT 2017



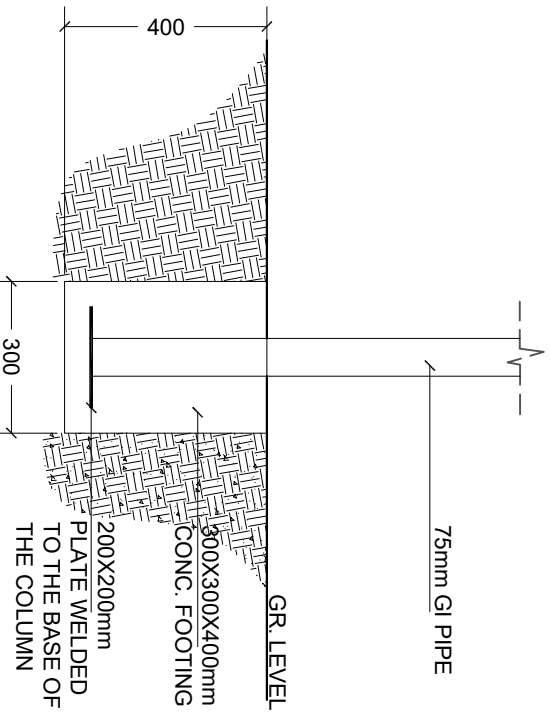

**WASTE SORTING AREA
COLUMN FOUNDATION DETAIL**

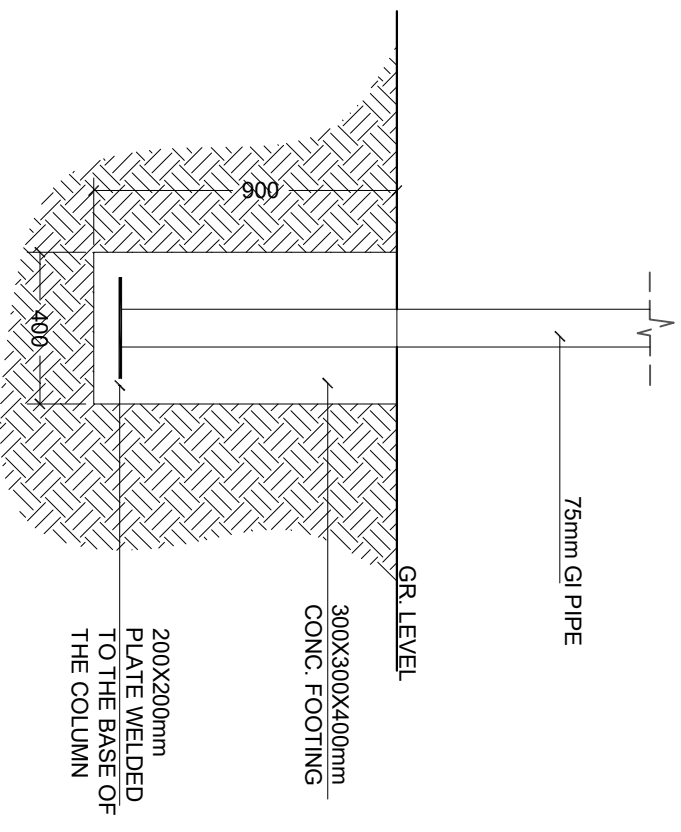

LIGHT POST FOUNDATION

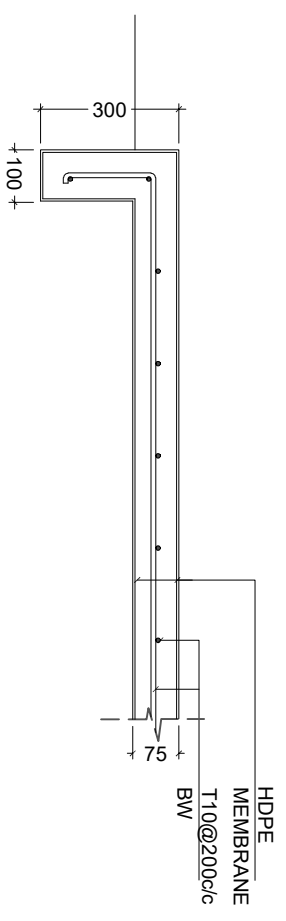
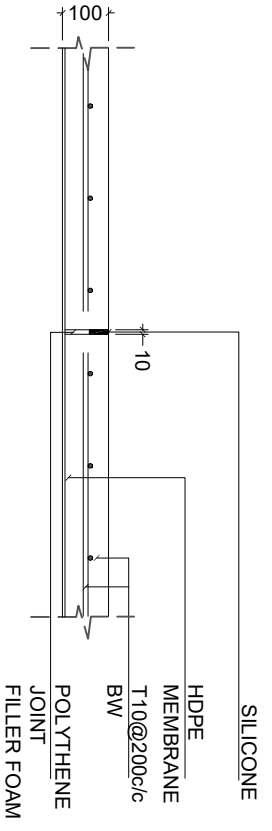
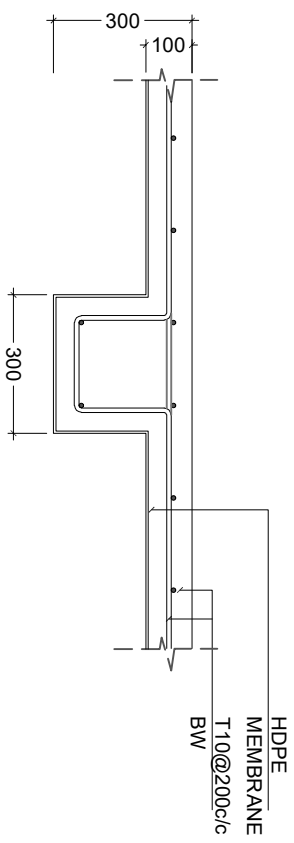
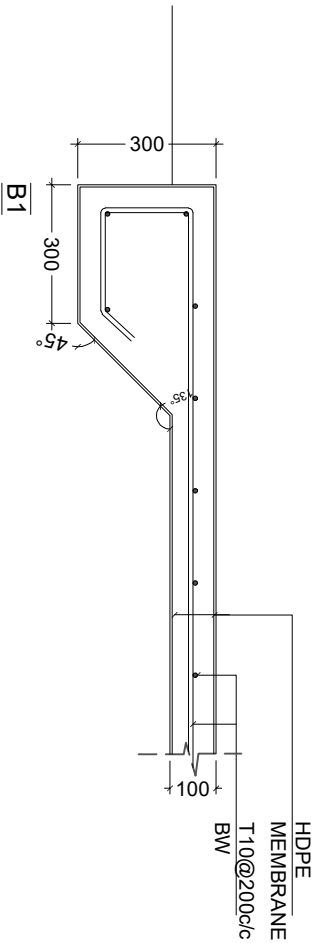

PROVISION OF WATER SUPPLY SANITATION AND SOLID WASTE MANAGEMENT PROJECT
 OPEC FUND FOR INTERNATIONAL DEVELOPMENT

PROJECT:
 H.A. KELAA ISLAND WASTE MANAGEMENT CENTER

SCALE: AS SHOWN
 DATE: OCT 2017



100MM PVC PIPE CUT IN
 HALF WITH 1% SLOPE TO
 LEACHATE WELL

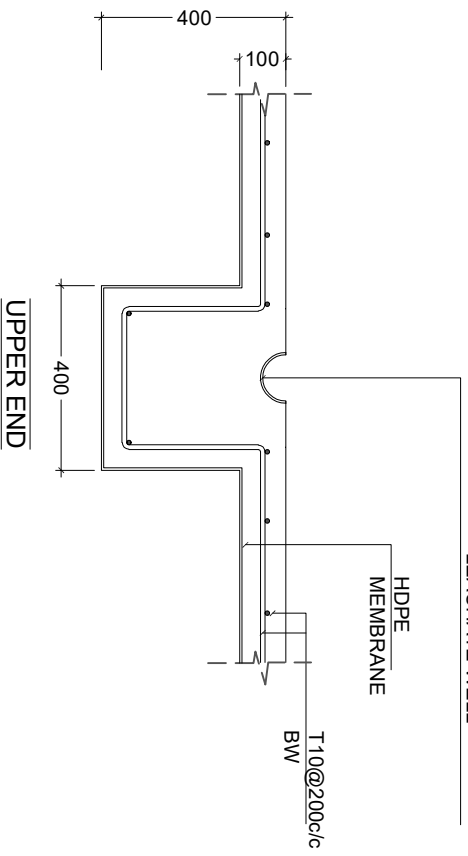

100MM PVC PIPE CUT IN
 HALF WITH 1% SLOPE TO
 LEACHATE WELL

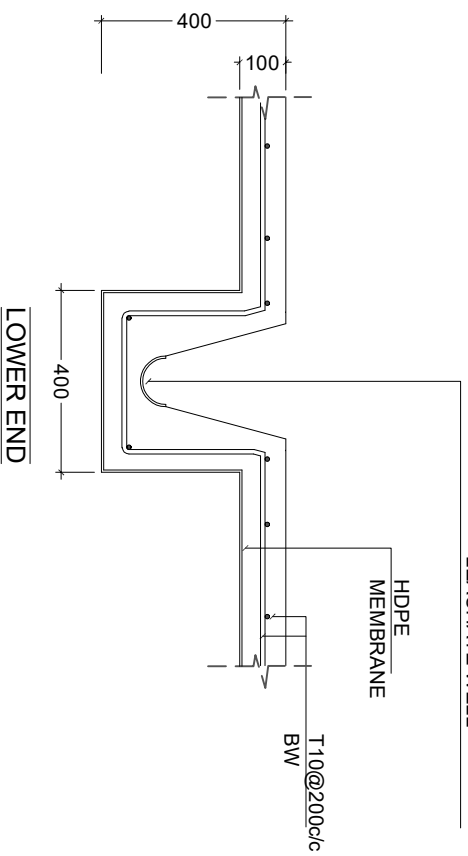

B3

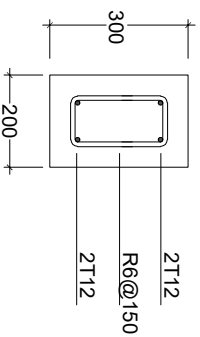
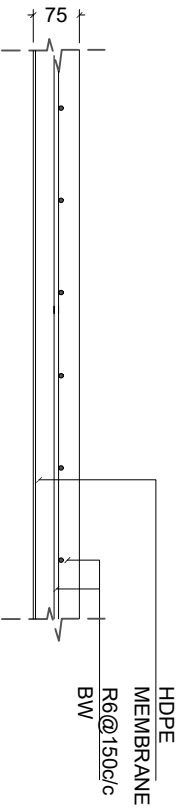

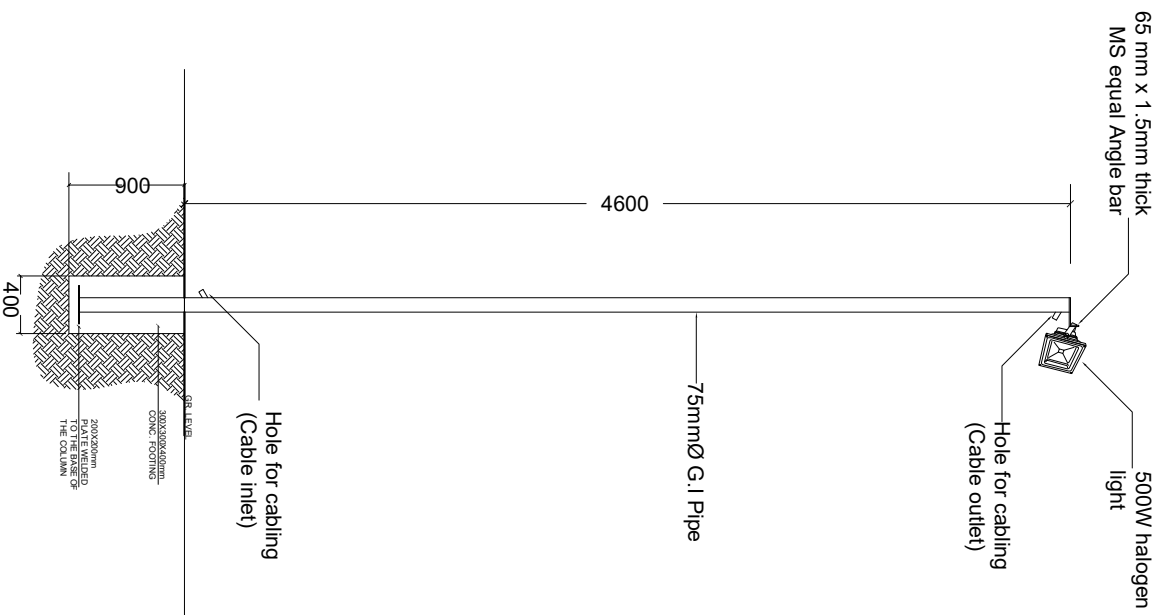

LIGHT POST DETAIL

* GI pipe to be painted with 1 coat of sealer & 2 coats of finishing paint. (Sigma, Grey colour)

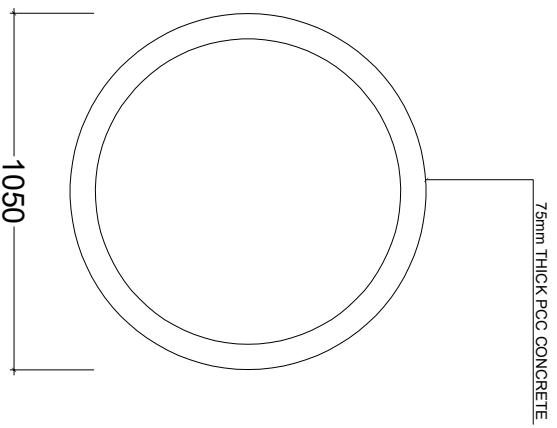

GROUND WATER WELL

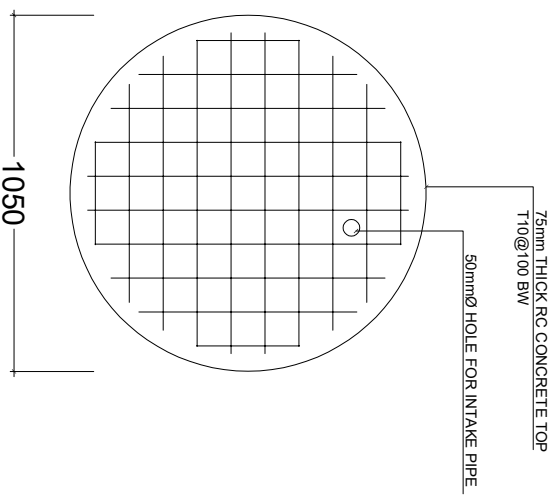

GROUND WATER WELL - TOP

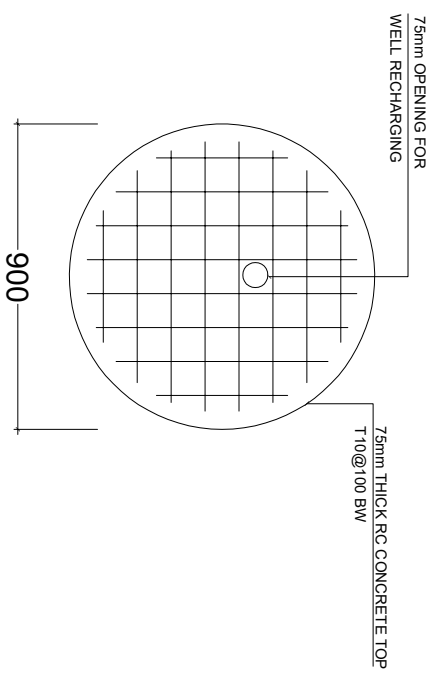

GROUND WATER WELL - BASE

PROVISION OF WATER SUPPLY SANITATION AND SOLID WASTE MANAGEMENT PROJECT
 OPEC FUND FOR INTERNATIONAL DEVELOPMENT

PROJECT:
 H.A. KELAA ISLAND WASTE MANAGEMENT CENTER

SCALE: AS SHOWN
 DATE: OCT 2017



STATE WATER MANAGEMENT DEPARTMENT
 MINISTRY OF ENVIRONMENT AND ENERGY
 KINGDOM OF BAHRAIN
 PROJECT NO. WWT-20-01

3000

1000

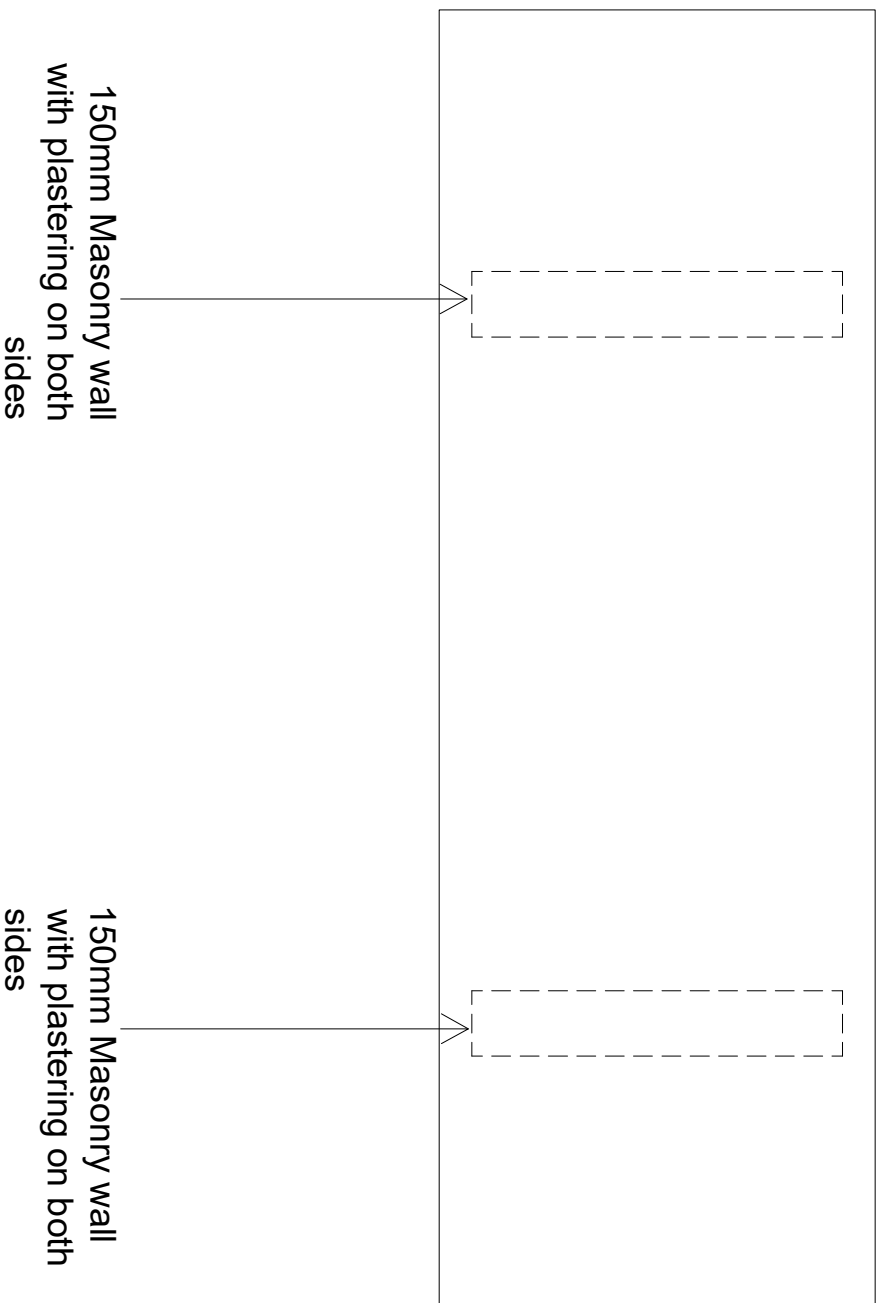

WASTE SORTING BENCH PLAN

PROVISION OF WATER SUPPLY SANITATION AND SOLID
WASTE MANAGEMENT PROJECT
OPEC FUND FOR INTERNATIONAL DEVELOPMENT

DRAWING:
WASTE SORTING AREA BENCH

SCALE: NTS
DATE: OCT 2017



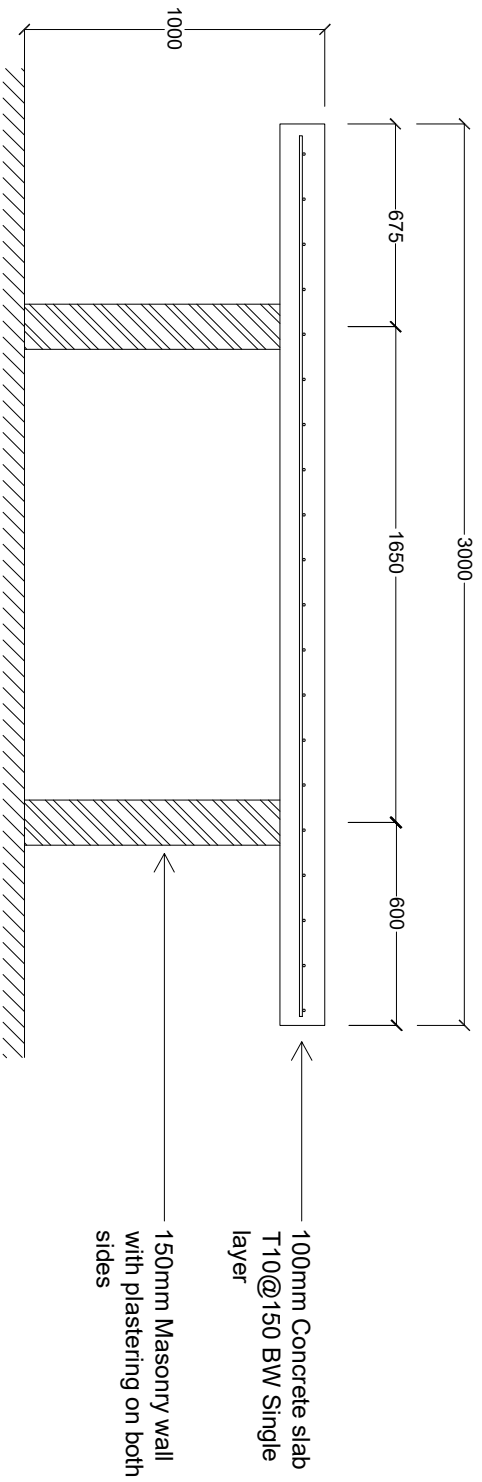

WASTE SORTING BENCH
LONG SECTION

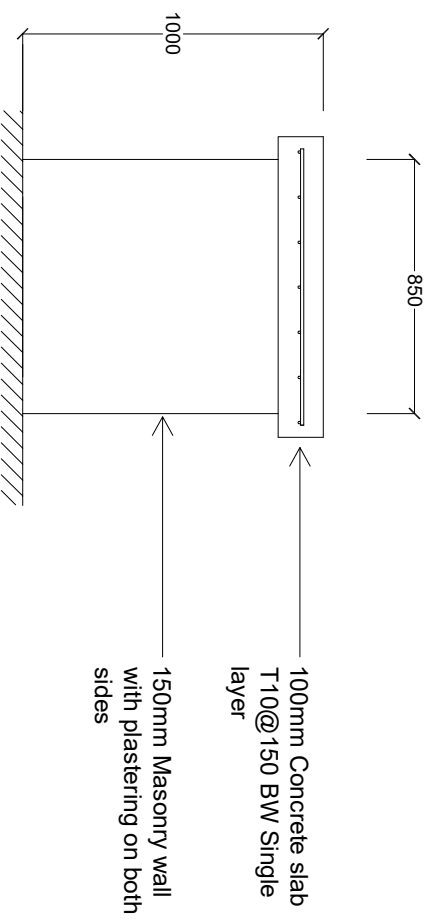

WASTE SORTING BENCH
CROSS SECTION